

STROKE CARE AT HOME



UNIVERSITEIT • STELLENBOSCH • UNIVERSITY
jou kennisvenoot • your knowledge partner



COMPILED AND EDITED BY ES SCHEFFER & SJ VISAGIE

CENTRE FOR
REHABILITATION
STUDIES,
STELLENBOSCH
UNIVERSITY

Copyright © 2011 Stellenbosch University. All rights reserved.
Revised edition © 2015 Stellenbosch University. All rights reserved.

Product of the Centre for Rehabilitation Studies, Stellenbosch University.

E-publication: Terms of use

1. This e-publication may only be reproduced, distributed, stored or transmitted in full, without any pages omitted.
2. Users may reproduce and distribute this e-publication in print and electronic format under the following conditions:
 - i All pages of the booklet, including the front and back pages, must be reproduced and distributed each time.
 - ii Copies of the e-publication may not be sold for commercial gain.
 - iii No part of this e-publication may be modified or altered in any form or medium without the copyright holder's prior written permission.



CONTENTS

4	IMPORTANT THINGS TO KNOW ABOUT A STROKE
6	PROBLEMS WITH COMMUNICATION
10	PROBLEMS WITH THE MIND (THINKING) AND BEHAVIOUR
12	HOW TO POSITION A STROKE SURVIVOR
18	EATING, SWALLOWING AND TOOTH/MOUTH CARE
24	SHOULDER CARE
28	MOVING IN BED
32	TRANSFERS (MOVING BETWEEN BED AND CHAIR)
40	SELF-CARE
54	WALKING WITH HELP
56	COMMON PROBLEMS AFTER A STROKE
58	ACKNOWLEDGEMENTS
59	WHY HAVE WE WRITTEN THIS BOOKLET?

Stroke Care Contact

IMPORTANT THINGS TO KNOW ABOUT STROKE



WHAT IS A STROKE?

A stroke is caused when there are problems with the flow of blood to a part of the brain. These problems may be one of the following:

- Damage or disease may block or narrow a blood vessel. This stops the blood from flowing, and means that oxygen (air) and nutrients (food) cannot reach certain parts of the brain. Those parts of the brain are then damaged and can stop working.
- A blood vessel may burst. The blood will then flood the brain and cause damage.



DO PEOPLE GET BETTER AFTER A STROKE?

Each stroke is different. It depends on the part of the brain that is damaged.

- Normally, people who survive a stroke get better slowly over a long time, but they almost never recover completely.
- Most people learn to walk again, but they walk slowly and can easily fall.
- Many people do not get back all the movement or control of their hand and arm.
- Some muscles stay paralysed or weak, and others become stiff. This makes it difficult for stroke survivors to move and control their bodies.
- Some people's physical abilities (body movements and control) become almost normal again.
- Some people continue to have problems with their mental functions (such as thinking, making decisions and knowing to stay away from danger).



CAN MEDICINE MAKE A STROKE BETTER?

It is not possible to make dead brain cells come alive again. But if you treat the health problems that caused the stroke, you can help to prevent further strokes. Common health problems that cause strokes are diabetes (high blood sugar), high blood pressure, high cholesterol (too much fat in the blood) and heart problems. A person who suffered a stroke should see a doctor to be treated for these diseases and to check that there are no other problems.



WHAT PROBLEMS DO PEOPLE OFTEN EXPERIENCE AFTER A STROKE?

People may experience the following problems after a stroke:

- Weakness or paralysis of one side of the body
- Stiffness of arm, hand and/or leg
- Struggling with balance, falling over easily when sitting and standing
- Struggling to speak or understand language
- Struggling to control their bladder and bowel (toilet needs) (but this usually gets better over time)
- Loss of feeling on the weak side of their bodies
- Seeming to forget about/ignore the weak side of their bodies
- Problems with vision (seeing)
- Seeming confused and struggling to remember
- Mood and personality changes
- Forgetting how to do everyday tasks



HOW DO I TREAT SOMEONE WHO HAS HAD A STROKE?

- Let the person spend as little time as possible in bed. Spending too much time in bed will cause more weakness. Rather let him/her take short rest breaks.
- Let the person get up at his/her usual time and get washed and dressed.
- Let the person have meals with the rest of the family as usual.
- Try to help the person to follow a structured daily programme.
- Encourage the person to do things for him/herself. Be patient and give him/her more time to complete and practise tasks. Doing as much as possible for him/herself and practising daily activities is good exercise.
- Remember that the person is an adult; never treat stroke survivors as if they are children.

PROBLEMS WITH COMMUNICATION



WHAT IS COMMUNICATION?

Communication is how we share information with each other through talking, gesturing (showing with our hands), writing or other ways, and our ability to understand that information.



WHAT COMMUNICATION PROBLEMS DO STROKE SURVIVORS OFTEN HAVE?

Stroke survivors may experience the following communication problems:

- Deafness or being hard of hearing. This may be part of getting older and isn't always because of the stroke. The nurse at the clinic can make sure that there is nothing blocking the outer ear (the part we can examine), such as wax.
- Struggling to understand
- Cannot plan speech (put the right sounds together to form words)
- Cannot find or think of the right words
- Cannot control the muscles that help us form words, such as the tongue and jaw muscles
- Cannot read, write or understand pictures
- Cannot speak loudly



HOW CAN I HANDLE THESE COMMUNICATION PROBLEMS?

When you are talking to a stroke survivor:

- Turn your face towards the person.
- Look the person in the eye.
- Stay close to the person.
- Talk slowly and clearly, especially if the person is tired.
- Use your normal voice. Do not shout.
- Repeat what you have said if the person does not understand.
- Use short sentences.
- Wait between sentences.
- Use gestures while talking (show with your hands).
- Talk about ordinary, everyday topics.
- If the person cannot speak, ask questions that can be answered with a simple 'yes' or 'no'.
- If you're not sure whether the person understood, ask him/her to repeat important information.

When you are listening to a stroke survivor:

- Be patient.
- Watch the person's lips.
- Remind the person to talk slowly and clearly.
- Remind the person to concentrate harder when using difficult words.
- Ask the person to repeat if you cannot understand. Don't make as if you understand.
- Encourage the person to use the names of friends and family.
- Encourage the person to use common words such as 'hallo' or 'thank you'.
- If the person cannot speak, encourage him/her to use hand gestures and to point to objects.

In general:

- Make sure there is no noise in the background.
- Turn the TV or radio down.

WHAT ELSE CAN I USE TO HELP WITH COMMUNICATION?

A	B	C	D	E	F	G
H	I	J	K	L	M	N
O	P	Q	R	S	T	U
V	W	X	Y	Z	0	1
2	3	4	5	6	7	8
9	10	YES	NO			

Use an alphabet board. Some stroke survivors may be able to spell out what they want.

Action Words

 Sit	 Read	 Walk	 Sleep
 Press	 Burn	 Write	 Work
 Sick	 Laugh	 Speak	 Spill
 Exercise	 Drink	 Eat	

GENERAL

 Telephone  Radio  Newspaper  Television

PEOPLE

 Woman  Doctor  Family  Son  Daughter

WORDS

Hello
Tomorrow
Goodbye
Sit
Walk

SENTENCES

I am thirsty.
I am hungry.
I want to go to the toilet.
What time is it?
How are you?
Is it going well?
Thank you very much!

Use a chart (poster) with pictures and/or words.

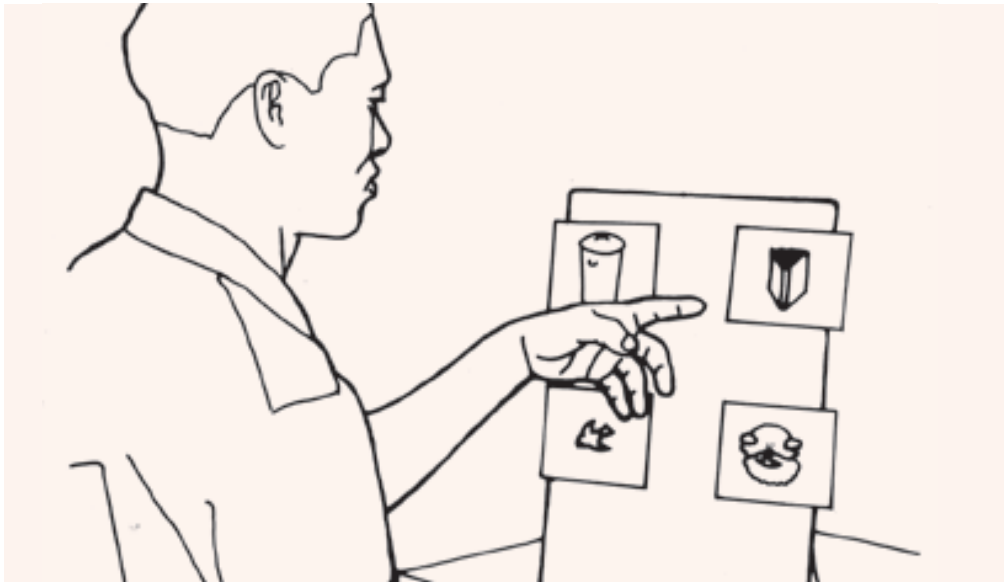

Use pictures.



Use hand gestures.

PROBLEMS WITH THE MIND (THINKING) AND BEHAVIOUR



WHAT PROBLEMS CAN OCCUR WITH THE STROKE SURVIVOR'S MIND AND BEHAVIOUR?

Because of the damage to their brain, some stroke survivors struggle to remember or understand things. Others find it difficult to control their feelings and urges (needs), and behave in strange ways. But not all stroke survivors have these problems. An occupational therapist can check whether a person experiences any of these.



WHAT ARE THE SIGNS OF THESE PROBLEMS?

You may notice the following:

- Confusion: The person doesn't recognise people, know where he/she is (place) or what the time or date is.
- Short-term memory problems: For example, the person cannot remember what was said an hour ago.
- Does nothing unless told: For example, the person will stay in bed unless being told to get up.
- Struggling with simple tasks: Tasks such as putting on a sweater becomes very difficult.
- Lack of control (for example temper, sexual desire or eating): The person may do things before thinking them through.
- Unsuitable behaviour: For example, the person may laugh at someone getting hurt.
- Being demanding: For example, a stroke survivor may want your attention immediately or all of the time.
- Ignoring the weak side of the body: For example, when looking for something, the person would not even try looking on the weak side of the body.
- Doesn't understand money or how to work with it.
- Depression/feeling extremely sad and 'down' all the time.
- Long excuses for strange behaviour, because the person is not aware of these problems.



HOW CAN I DEAL WITH THESE PROBLEMS?

- Get professional help from an occupational therapist or a behavioural psychologist (ask your local clinic to refer you to the right person).
- Tell the stroke survivor the date, day and time often. Put a clock and a calendar in the room and show it to the person regularly.
- Follow the same daily routine, with meals, personal care (bathing, brushing teeth, combing hair) and resting at the same time and in the same way, every day.
- Start explaining any changes in the routine long before the time, for example when you need to go to the shop or the clinic. Repeat the explanation often.
- Do not allow certain behaviour the one day and refuse it on other days. Decide what you see as acceptable behaviour, and stick to it.
- Do not allow the person to control you with bad behaviour. For example, don't give in to what the person wants just because he/she keeps shouting.
- Have clear rules for unacceptable behaviour. For example, say: 'Do not shout. I will not answer you if you shout.'
- Do not laugh at strange and bad behaviour, such as swearing, even if it is funny.
- Tell the person when his/her behaviour is good and acceptable. For example, say: 'I enjoy helping you when you are thankful.'
- Let the person help make decisions.
- Let the person do as much as possible for him/herself, but stay close enough to make sure he/she is safe, for example in the bathroom and kitchen.
- It is normal for stroke survivors to cry more easily. If the crying is not because of depression, distract the person by asking him/her to count to ten or to breathe deeply. Don't show too much sympathy because it will make the crying worse.

HOW TO POSITION A STROKE SURVIVOR

When stroke survivors sit or lie down in the right way, it can help them recover faster and function better. Sitting or lying in incorrect positions may worsen problems such as stiffness, pain or interfere with awareness of the weak side.

?

HOW SHOULD THE PERSON LIE IN BED?

General guidelines:

- Use a firm mattress (not too soft, not too hard), or place a wooden board such as an old door under the mattress.
- The wall should always be on the person's strong side.
- The person should lie with the weak side of the body towards the door, TV, visitor's chair and so on. This will help him/her not to forget or ignore the weak side.
- The person should spend as little time as possible in bed.
- When in bed, the person should lie on his/her sides instead of on the back.
- Turn someone who cannot move at all every two to three hours to prevent stiffness and bedsores.

How to sleep on both sides



Lying on strong side.



Lying on strong side.

- 1 Keep the elbow away from the body and in a comfortable position.
- 2 Keep the weak hand open, with nothing in it.
- 3 When lying on the strong side, put something under the weak elbow and hand to support it.
- 4 When lying on the weak side, don't let the person lie on the shoulder joint. Place the shoulder in front of the chest and not under the body.
- 5 Bend the upper knee.
- 6 Place pillows or a folded blanket under the upper knee and foot so that it is fully supported.
- 7 If the bed is not wide enough, let the weak hand and arm rest on a cardboard box or table next to the bed. Check that the box or table is just as high as the bed - not lower or higher.

How to lie on the back

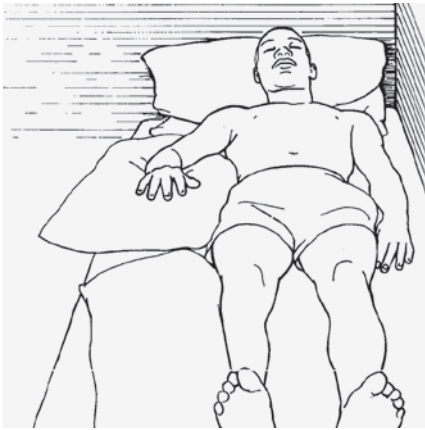

Do not let the person lie in bed with a stack of pillows stuffed behind his/her back.

This may cause:

- Bedsores
- Breathing problems
- Problems with swallowing
- More stiffness in the arm and leg
- A bent spine and forward head position

- 1** The person may lie on his/ her back only for a short time only.
- 2** Put the bedside table on the weak side.

How to sit up in bed (only if the person cannot get out of bed)

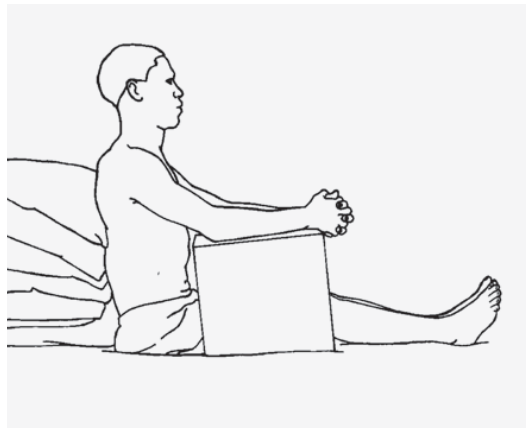
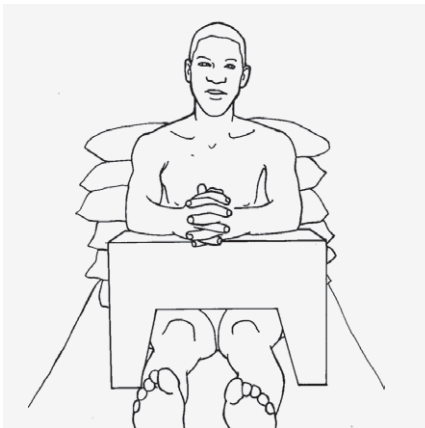

- 1** Let the person sit up straight with legs stretched out in front. If you put a pillow under the knees it may be more comfortable.
- 2** The back should be against the wall or headboard. If the person cannot be moved closer to the upper part of the bed, place a chair or stool between him/her and the headboard.
- 3** Put pillows or a folded blanket behind the back as support
- 4** Make a lap table from a box (see below), on which the arms can rest.
- 5** The person should only sit like this if he/she cannot get out of bed.

How to make a lap table from a cardboard box

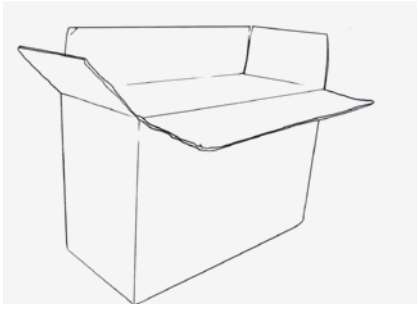

1 Use a strong box that is wide enough to fit comfortably over both thighs.

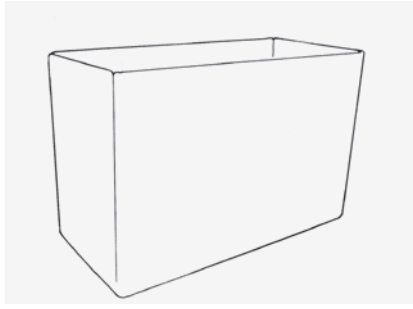

2 Cut off the flaps or glue them to the inside of the box to strengthen the sides.

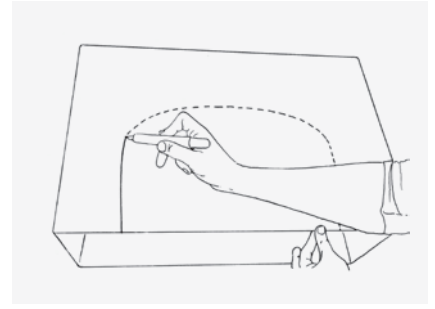

3 Draw an arch on both sides of the box. This is to make an opening for the legs to go underneath the table, so make sure it's big enough.

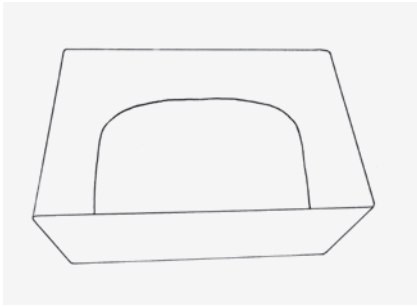

4 This is what the arch should look like when it's done.

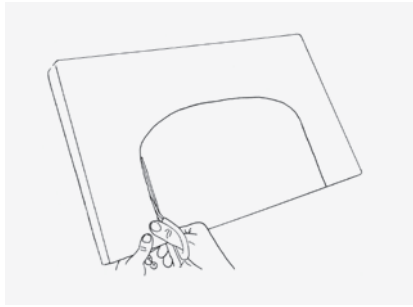

5 Now cut out the arch along the line.

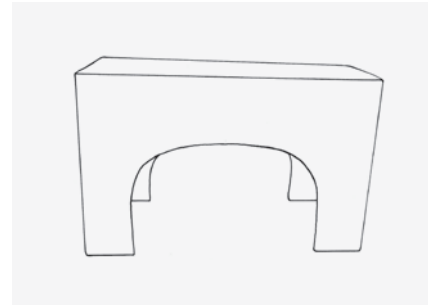

6 Your lap table is now ready to use.

?

HOW SHOULD THE PERSON SIT?

How to sit in a chair or wheelchair



Always use a wheelchair cushion on a wheelchair.

General guidelines:

- The chair must be as narrow as possible so that the person fits into the chair snugly.
- The chair must be firm. Use a hardback chair with a firm seat instead of an easy chair (stuffed chair).
- The person must sit up as upright as possible, with his/her back straight up against the back of the chair.
- The person's bottom must be against the back of the chair. If he/she does not feel balanced or comfortable with the bottom all the way back, place a small pillow at the back of the seat.
- Place the person's feet on the floor or on footrests for support. If the feet do not reach the ground, support them on a wooden block, a stack of newspapers or cardboard tied together.



When stroke survivors do not sit in the right way, it can cause:

- Discomfort or pain
- Stiffness of the weak leg or arm
- Swelling of hand and arm
- Sliding out of chair

?

HOW CAN STRAPS PREVENT SLIDING OUT OF A CHAIR?

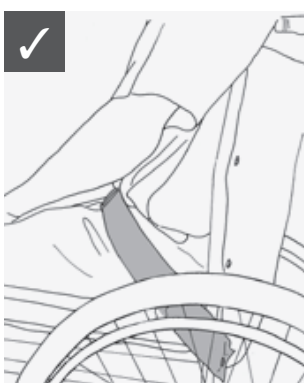

Strap the person in across the hips, with the strap coming from the lower back corners of the chair.

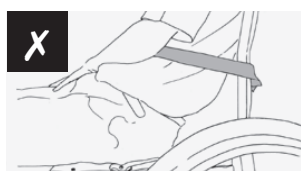

Do not strap around the tummy or chest. The person will still slide if you use the strap around the tummy or chest.



HOW MUST A LAP BELT BE FIXED TO A CHAIR?

For a wheelchair

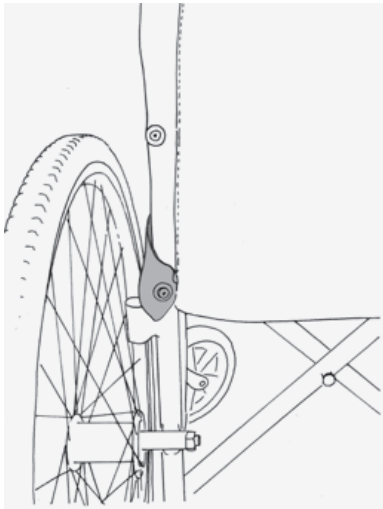

- 1** Fix the belt to the wheelchair frame by using the bottom screw of the wheelchair backrest or the rear screw on the seat.

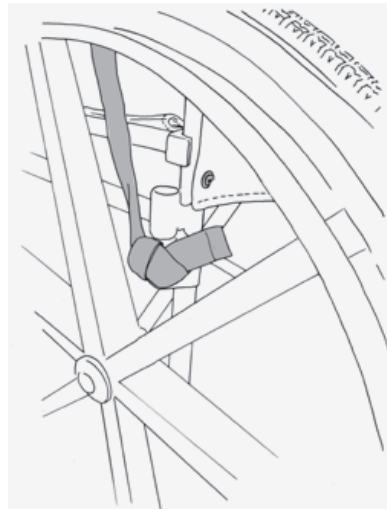

- 2** You can also tie the belt to the upright part of the wheelchair frame, just below the rear end of the seat.

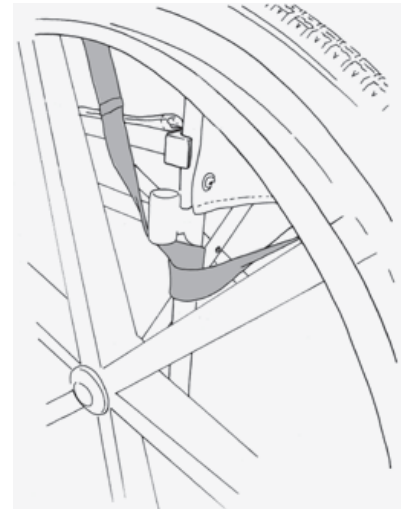

- 3** If you use one long belt that fastens in front of the person, hook and loop it around the upright part of the wheelchair frame on one side, below the rear end of the seat.

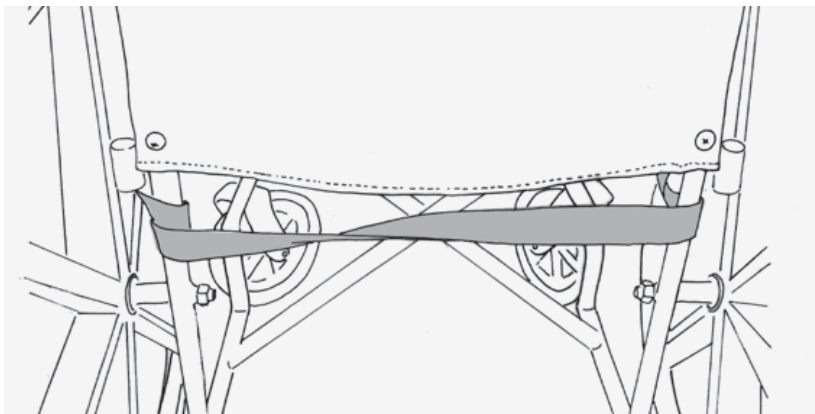

- 4** Then run it around the back to the opposite side of the frame and below the rear end of the seat.

For an ordinary chair



Tie the belt to the back legs of the chair, just below the seat.



HOW CAN I SUPPORT THE ARMS AND HANDS?

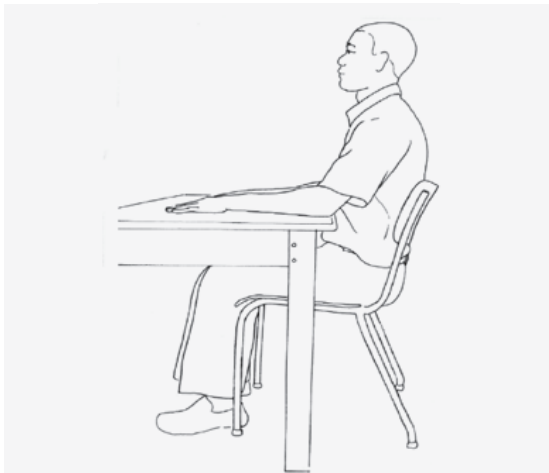

Do not put the arm in a sling.

General guidelines:

- Always make sure that the whole forearm, including the elbow and hand, rests on a table, armrest or tray table. See the example of a tray table below.
- The hand should be open and placed palm down, flat on the table, armrest or tray.
- Do not use pillows on the lap to support the weak arm while the person is sitting. This does not give enough support, and the hand may swell up or the shoulder joint may stretch open. (Shoulder care is described in Chapter 6.)

An example of a tray table

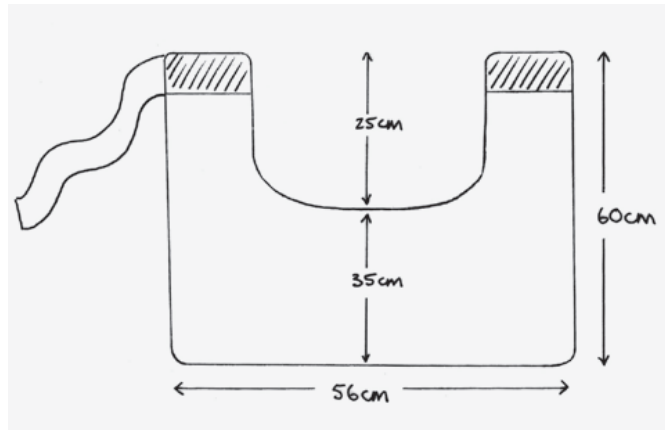
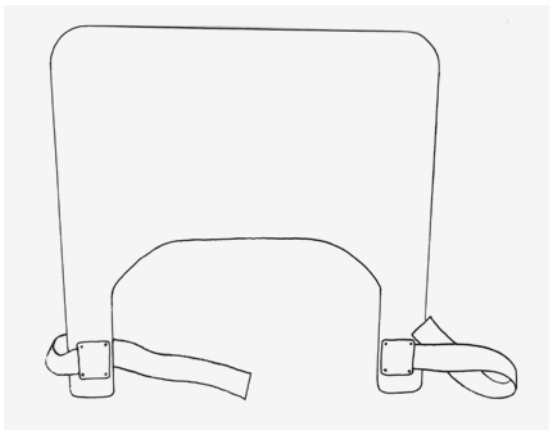

One can make a tray table from thick hard board or thin plywood. Sand down the surface and edges of the tray table. The surface can be painted or varnished to protect the table from water damage and to allow easy cleaning. The size can be adapted according to the measurements of the chair and the person.

EATING, SWALLOWING AND TOOTH/MOUTH CARE



HOW CAN I HELP THE PERSON EAT?

The person must do the following:

- Sit up for all meals
- Sit up straight
- Keep the head slightly forward
- Look at the food
- Rest arms on a table
- Keep the feet flat on the footrest of the wheelchair or on the floor
- Take small bites and sips
- Move the chewed food to the middle of the tongue before swallowing
- Drink from a full glass or use a straw to prevent the head from tipping back
- Sit up for at least 20-30 minutes after eating for food to be digested

If the person often coughs or chokes when eating, ask to see a speech therapist. He/she can check whether the person can swallow food and drinks safely, and give the necessary advice to improve swallowing.

The carer must do the following:

- Sit up for all meals
- When standing, put your foot on a low support, such as a wooden block or low bench.
- Always keep your back straight; don't bend it
- Use your arm closest to the person to support his/her head
- Place food between the teeth, on the stronger side of the person's mouth
- Give thick fluids and food with a smooth texture. Yogurt, custard and thick soups are easiest to swallow



Don't let the person's head tip to the side or the back.

- Don't let the weak arm dangle or fall off the table, armrest or lap tray.
- Don't let the feet slip off the footrests of the wheelchair.

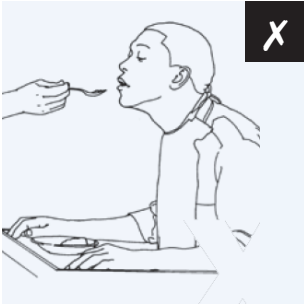

The person should not have to bring his/her neck and head upward or forward to reach the food. This makes it difficult to swallow

- Hold the spoon directly in front of the mouth
- Take the spoon to the person's mouth. The person should not have to move his/her head toward the spoon

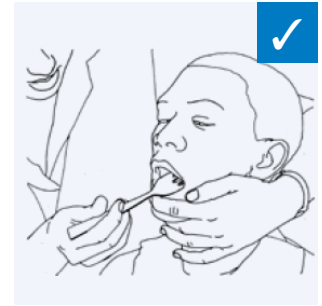
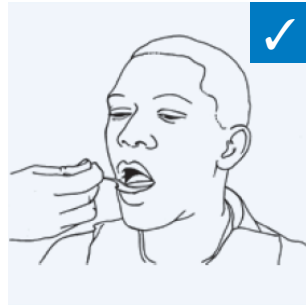

?

HOW CAN I HELP THE PERSON DRINK?



- Put your finger on the person's cheek, chin and lower jaw to help him/her close the lips or mouth. Take care not to tilt the head back

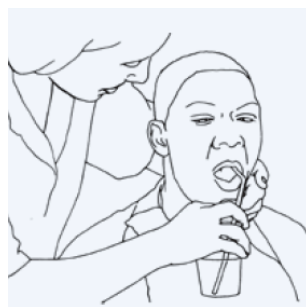

- When using a straw, always put it on the strong side of the mouth against the cheek

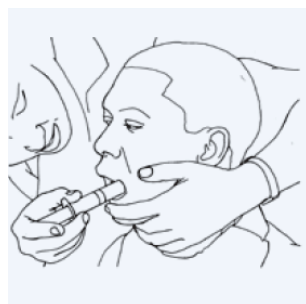

- If the person cannot drink from a cup or use a straw, use a syringe (injection) without the needle to put fluids into the mouth
- Place it on the strong side of the mouth, against the cheek. Squirt fluid in the direction of the cheek.

?

HOW CAN I HELP A PERSON WHO STRUGGLES TO GET THE FOOD ONTO A FORK/ SPOON WITH ONE HAND?

Use a deep plate or a plate with a guard to prevent food from sliding off the plate

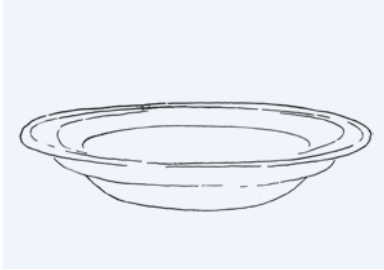

Deep plate.



A plate with a plate guard bought in a store.



Home made plate guard.

How to make a plate guard



1 Take an empty one or two-litre plastic milk or juice bottle.



2 Draw a horizontal line 5 cm from the bottom of the bottle (running along with the bottom).



3 Now draw a line that runs through the horizontal line, across the bottom of the bottle.



4 Cut along the horizontal line to remove the bottom of the bottle.



5 Take off the bottom.

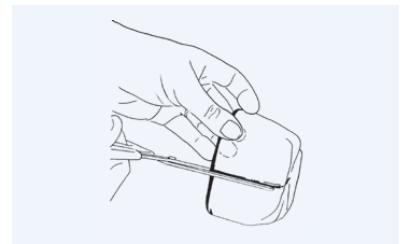

6 Cut the bottom into two pieces along the line that runs through the middle.



7 You now have two loose pieces of bottle bottom.

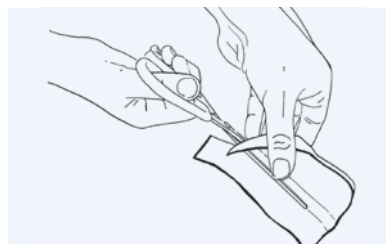

8 Use one of these pieces. Cut the one side to be as wide as the edge of the plate.

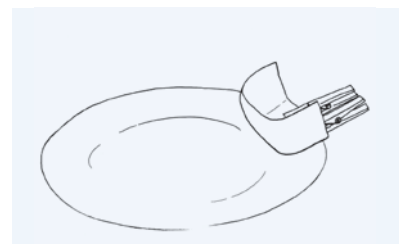

9 Attach it to the edge of the plate with clothes pegs.

How to make a spreading and peeling board for persons who can use only one hand



Spreading with one hand.

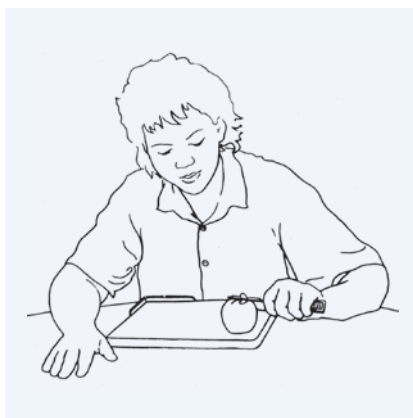

Peeling with one hand.

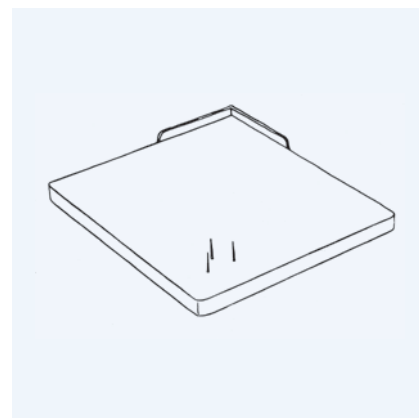

One hand spreading and peeling board.

You need:

- A piece of wood, such as an old bread board, 15 cm x 15 cm
- Three 8 cm nails
- Four short nails
- Two strips of metal or strong plastic, 6 cm long and 1 cm higher than the wood

Method:

- 1 Hammer the three long nails into one corner of the wood to form a triangle or square (see picture).
- 2 Use the short nails to attach the metal or plastic strips to either side of the corner opposite the nails. The strips should stick out 1 cm above the board.

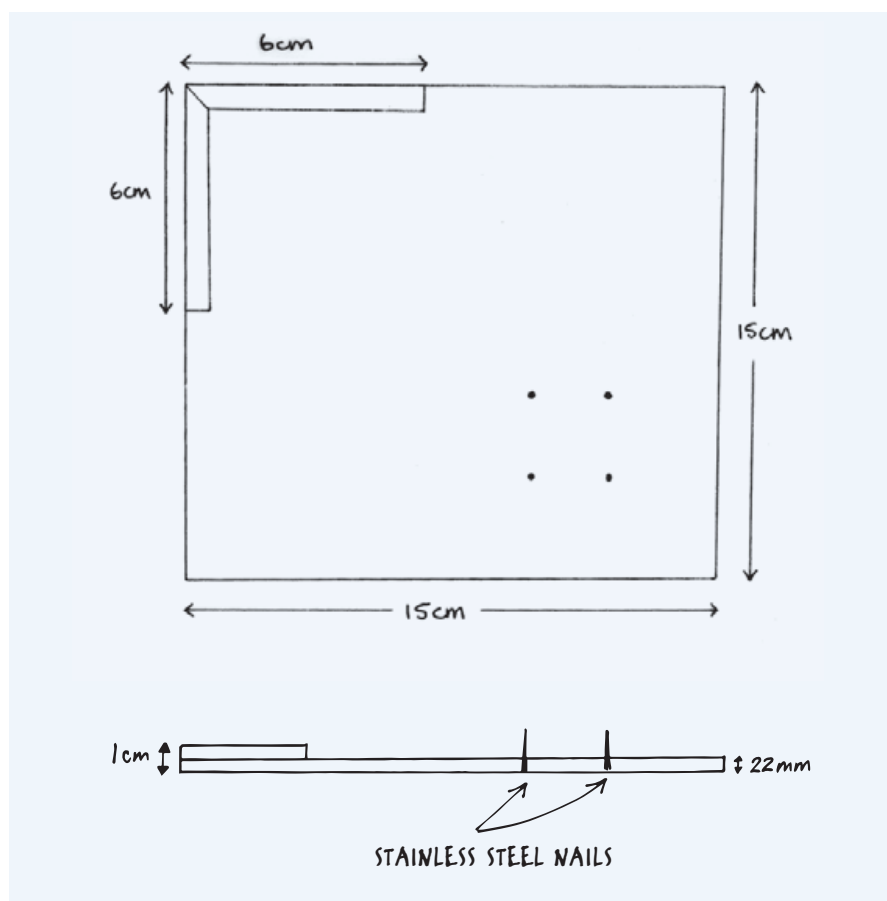

Measurements and technical details for the spreading and peeling board

How to make a larger grip if the person struggles to grip a thin handle

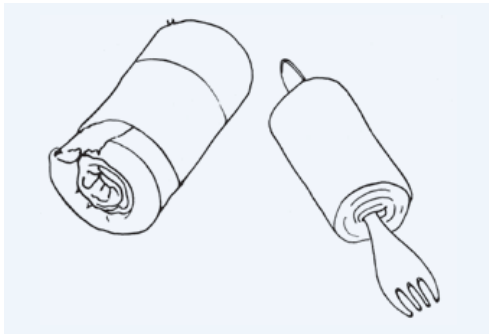

You need:

- Spoon or fork
- About 6 cm x 10 cm high-density foam (depending on the length of the spoon and how thick the grip should be)
- Elastoplast/duct tape

Method:

- 1** Roll the foam around the grip of the spoon or fork to make the grip area bigger.
- 2** Tie down with Elastoplast/duct tape.

?

HOW CAN I HELP THE PERSON BRUSH HIS/ HER TEETH?

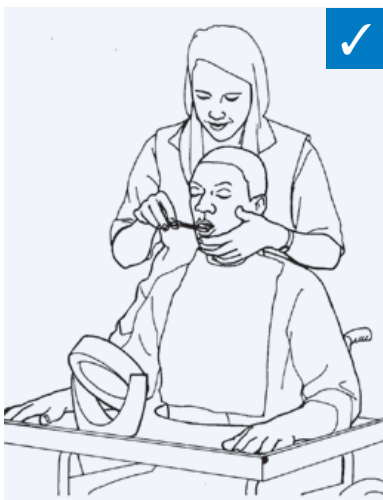

- 1** Let the person sit in front of a mirror.
- 2** The person must sit up straight.
- 3** Keep the head upright.
- 4** Let the weak arm rest on a table or on the edge of a basin.
- 5** Stand behind the person and look in the mirror.



Do not tip the person's head to the back or the side.

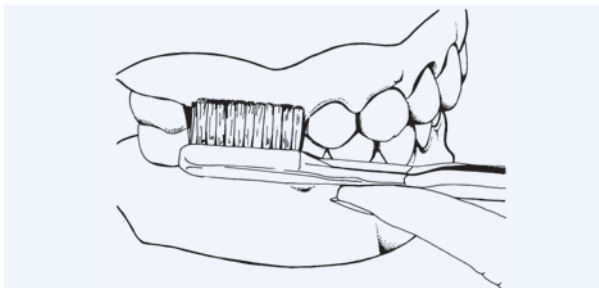

- 1** Hold the brush at a 45° angle (slightly tipped) to the person's gums and teeth.



- 2** Brush in small circles.

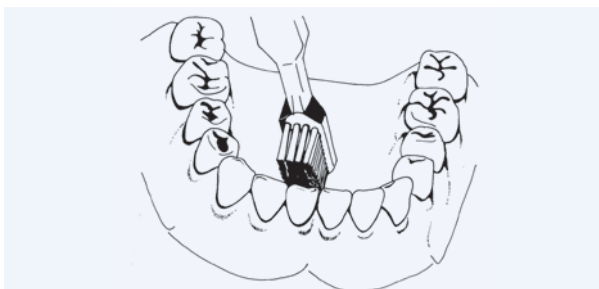

- 3** Brush both the inside and outside of the teeth.



- 4** Use a floss holder to floss between the teeth. See an example of a floss holder on the following page.



HOW CAN I HELP SOMEONE WHOSE HAND IS TOO WEAK TO HOLD A TOOTHBRUSH?

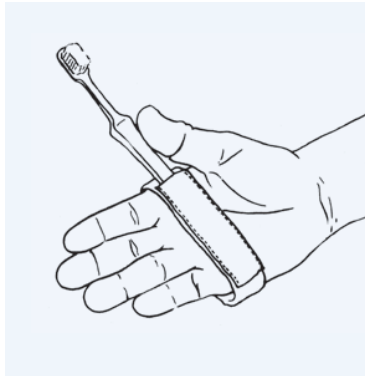

A simple brush holder can be made from strong, non-stretchy fabric such as upholstery fabric or webbing. Make a strap that attaches to the hand with Velcro. Stitch a pocket on the part in the palm of the hand in which the toothbrush can fit. The pocket should fit tightly around the toothbrush so that the toothbrush is kept still.

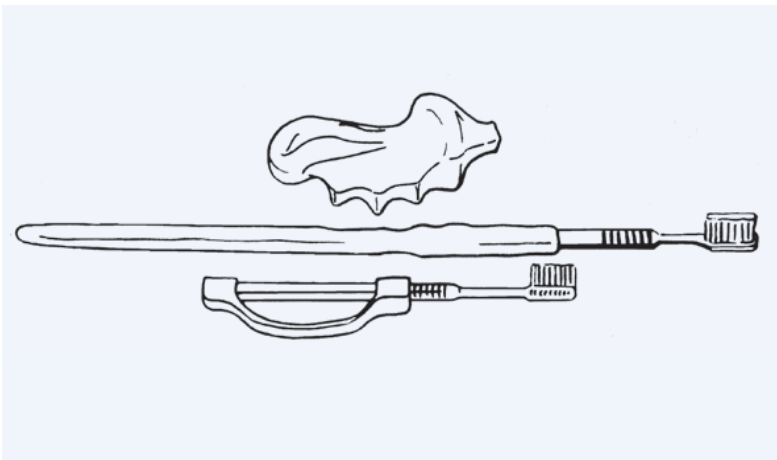

Other options to improve the grip include:

- Use a bigger grip. You can make a bigger grip yourself as described before, or buy it from a specialist shop.
- Use a longer handle. This works well for a person who struggles to lift his/her hands up high enough.
- Buy a brush holder from a specialist shop.

SHOULDER CARE

Many people who have had a stroke develop a painful and/or stiff shoulder. You can prevent this by handling the shoulder in the right way.

?

WHAT IS THE CORRECT WAY TO HANDLE A WEAK OR PARALYSED ARM?

General guidelines:

- Support the person around the rib cage to help him/her roll, sit up, stand up, and so on.
- Don't pull on the person's arm.
- Before washing or dressing the weak arm, always make sure that the shoulder is loose (free to move).

Never pull on the weak arm.



1 Hook your hand around the shoulder blade on the weak side.

2 Pull the shoulder blade gently sideways and forward.

3 Repeat this a few times until the shoulder moves freely.



4 Keep the shoulder blade in a forward position.

5 Grip the arm just above the elbow and carefully turn the arm and hand outward.

6 Stop if the person feels pain.

7 Do not grip the hand or lower arm because this may cause pain or damage to the elbow.



8 Once the arm moves freely, gently take the person's upper arm above the elbow and move the arm away from the body.

9 Straighten the elbow.

10 Now move the shoulder joint carefully upward and/or to the side for dressing and washing.

?

WHAT SHOULD I DO WITH THE SHOULDER WHEN TURNING SOMEONE IN BED?

- Before turning the person onto his/her weak side, loosen the shoulder blade in the same way as described above, and then pull it forward (onto the rib cage).
- Support the arm and shoulder in the forward position. While you keep this position, the person can roll onto the weak side.
- Don't let the person lie on the shoulder joint.

?

HOW SHOULD I SUPPORT THE SHOULDER WHILE THE PERSON IS SITTING?

- Support the elbow right next to the side of the body to keep the shoulder joint in a safe position. The support must be high enough so that the shoulders remain level.
- If the support is too low or too far away from the body, the upper arm bone may drop out of the socket and the shoulder joint will then stretch open and cause pain.

?

WHY SHOULD I NOT USE A SLING?

A sling that makes the arm rest in front of the body will cause even more stiffness, will shorten the muscles around the shoulder, and will make it impossible to move the hand to the side of the body. This will cause the muscles to pinch when the arm is lifted for dressing or washing. A sling may also cause the wrist to bend and get stiff, and may also cause the hand to swell.

?

WHY MUST I NEVER GIVE THE PERSON A BALL TO SQUEEZE?

Never give a person a ball to squeeze with the weak hand because this will increase stiffness of the hand and will make it more and more difficult to open the fingers to wash and dry the hand.

?

WHAT IS A GOOD EXERCISE FOR THE SHOULDER?

A simple exercise to keep the shoulder, elbow and wrist moving freely and comfortably

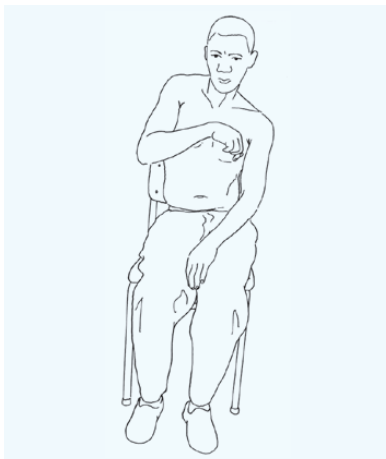

- 1** Use a firm chair with good back support. Let the person sit with his/her bottom touching the back of the chair and feet resting on the floor.



- 2** Now let the person bend forward and bring the weak elbow gently to the inside of the weak knee.



- 3** The person grips the weak shoulder blade with the strong hand by reaching underneath the armpit or over the shoulder. The upper body is pulled down gently towards the strong knee. Repeat until the shoulder blade has moved forward as far as possible.



- 4** The person keeps his/her body bent forward, takes the weak hand at the wrist, and gently starts to straighten the elbow over the knee.



- 5** Slowly straighten the arm between the knees towards the feet until the elbow is as straight as possible.

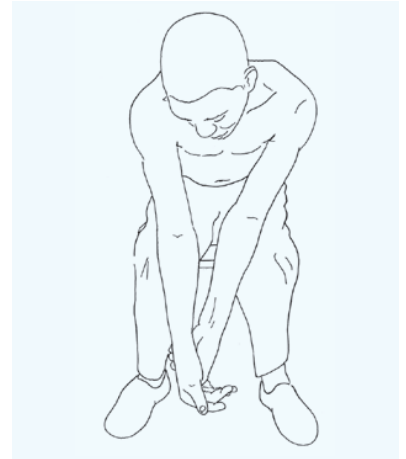

- 6** If possible, let the person stretch down to the floor.



- 7** Now let the person slide his/her arms to the side until they are on either side of the weak knee. Hands should stay as close as possible to the foot.



- 8** Start sliding the hands up to the weak lower leg.



- 9** Continue to slide the hands up the weak thigh.



10 Bring the hands over to the middle of the body and slide them up the chest.



11 The person then slides his/ her hands up to touch the nose. Continue only if there is no pain.



12 Slide further up to the top of the head. Continue only if there is no pain.

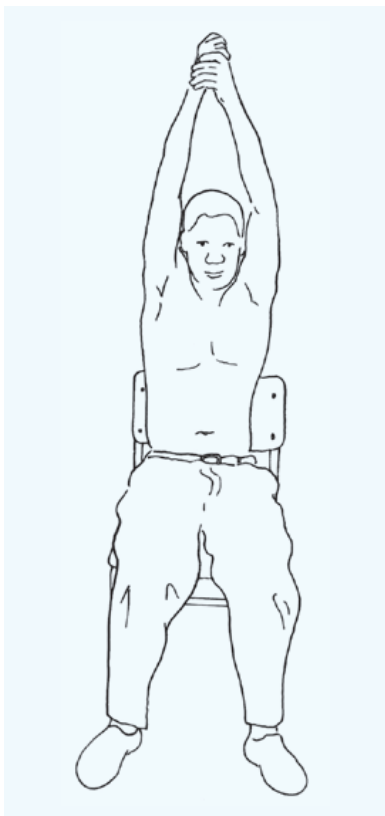

11 If the shoulder is not painful or stiff, the person should stretch the arms all the way up or as high as possible without causing pain.

11 Repeat this exercise five to ten times in a session, at least once a day. Get the person to try to stretch the joints a little further each time you do the exercise.

11 Do not continue to stretch if there is pain. If painful, stop stretching and repeat some of the earlier steps of the exercise.

MOVING IN BED

The general principles are:

- Never pull on an arm or a leg.
- Always explain to the person what you want to do.
- Ask the person to help as much as possible.
- Stay close to the person without crowding him/her.
- Bend your knees and keep your back straight.

HOW DO TWO PEOPLE HELP SOMEONE MOVE IN BED?

In a low bed



- 1 Bring the person into a sitting position and bend his/her knees.
- 2 Both carers face the person and bend their legs closest to him/her to kneel on either side of the bed.
- 3 The carers put their shoulders against either side of the person's body, just below the armpits. The person can put his/her strong arm over the carer's back.
- 4 The carers should take care not to push their shoulders into the armpits.
- 5 The carers support themselves on their hands furthest away from the person.
- 6 The carers wrap their other hands around the person's upper legs close to the bottom.
- 7 Both carers squeeze their shoulders against the person's body.
- 8 The carers should take care not to push their shoulders into the The carers lock their arms that are closest to the person around his/her legs close to the bottom.
- 9 The carers ensure good grip, and straighten their outside legs, lift and move the person.
- 10 The carers wrap their other hands around the person's upper legs close to the bottom.

In a high bed



- 1 Bring the person into a sitting position and bend his/her knees.
- 2 The carers stand on each side of the bed, facing the person.
- 3 The carers' feet should be shoulder width apart, with the back foot in line with the person's body, and the knee slightly bent. Their front feet should be turned in the direction of movement.
- 4 The carers put their shoulders against the person's body, just below the armpit, taking care not to push their shoulders into the armpits. The person can put his/her strong arm over the carer's back.
- 5 The carers support themselves on the hands furthest away from the person.



- 6** The carers wrap their other hands around the person's upper leg close to the bottom.
- 7** To lift the person, both carers squeeze their shoulders against the person's body, lock their arms around the legs and grip the legs.
- 8** If the person is big or heavy, instead of leaning on the other arm, a carer can place that hand under the person's bottom to help lift the weight.
- 9** The carers lift and move the person by straightening their knees and shifting their weight onto their front legs and supporting arms.



?

HOW CAN I MOVE SOMEONE WHO CAN MOVE A LITTLE ON HIS/HER OWN?



- 1** Kneel with one knee on the bed next to the person.
- 2** Help the person to bend his/her knees.
- 3** The person's feet stay flat on the bed. Put your knee in front of the feet so that the feet don't slide.
- 4** Help lift the hips.
- 5** Then help to move the hips to the side.



- 6** Grip the person firmly behind the shoulders.
- 7** Ask the person to lift his/her head.
- 8** Help him/her lift and move the head and shoulders by gripping the shoulders.
- 9** Do not pull on the neck or arms.
- 10** Move to the side by first lifting and moving the head, then the shoulders and then the hips.

How to roll the person onto the weak and strong sides



- 1** Ask the person to clasp his/her hands together or grip the weaker arm below the wrist with his/her thumb pointing to the fingers. The person should gently stretch the weak shoulder blade forward.
- 2** Bend the knee that must roll over, and then roll the body.
- 3** Ask the person to lift the head and shoulders.
- 4** Support the person at the hips and shoulder blade.

How to help a person from a lying into a sitting position



- 1** Roll the person onto his/her side.



- 2** Swing his/her legs over the edge of the bed.



- 3** You can provide support with one hand under the rib cage and the other on the opposite shoulder, or by placing both hands on the shoulders. You can also put one hand on the person's shoulder and the other hand on the hip.



- 4** Ask the person to push down onto the bed with both arms to lift the body. The person should never hold onto you or pull on your neck.



HOW CAN I GUIDE SOMEONE TO MOVE IN BED WITHOUT HELP?

How to move in bed



Ask the person to:

- 1** Bend his/her knees.
- 2** Keep his/her feet flat.
- 3** Lift his/her hips by pushing down on the feet.
- 4** Shift to the side or push upward.
- 5** Lift his/her head and shoulders and move.

How to roll in bed



Ask the person to:

- 1** Shift to the side of the bed as described above.
- 2** Clasp his/her hands together or grip the weaker arm below the wrist with his/her thumb pointing to the fingers.
- 3** Lift his/her arms up, and gently draw the weak shoulder forward.
- 4** Lift the head, shoulders and leg.
- 5** Roll over

How to sit up

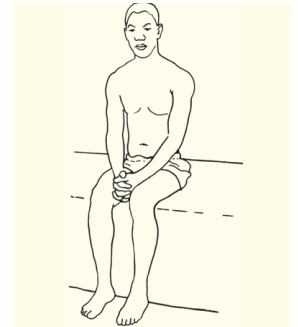

Ask the person to:

- 1** Roll onto his/her side.
- 2** Hook his/her strong foot behind the weak one and swing the legs over the edge of the bed.
- 3** Come up onto the elbow by pushing down with both arms.
- 4** Continue to push onto both hands and straighten the elbows.
- 5** Straighten out all the way and be sure to sit back far enough so that the bed fully supports the thighs.

TRANSFERS (MOVING BETWEEN BED AND CHAIR)

General principles:

- Position the wheelchair or chair close to the bed.
- Lock the wheelchair brakes.
- The taller or stronger carer should be at the back.
- The carers must work together.
- Decide beforehand who will give the instructions, and what these instructions will be.
- Indicate when you will start the lift, either by lifting on 'three' when counting to three or saying: 'One, two, lift.'

?

HOW SHOULD TWO PEOPLE MOVE A PERSON WHO IS VERY WEAK FROM A CHAIR TO A LOW BED?



Person's position:

- 1 The person folds his/ her arms.

Position of carer at the back:

- 2 The carer at the back slides his/her arms in between the person's upper arms and rib cage.
- 3 The carer grips both the person's forearms close to the elbows.



Position of carer in front:

- 4 The other carer kneels or squats in front of the bed, with one leg in front of the other.
- 5 This carer puts his/her arms under the person's knees and upper thighs, as close as possible to the bottom.
- 6 The person's legs may rest on the carer's thigh or can already rest in part on the bed.

Action of carer in front:

- 7 The carer in front lifts the person's legs, holding them close to his/her body, and shifts weight forward onto the other leg to move the person over to the bed.

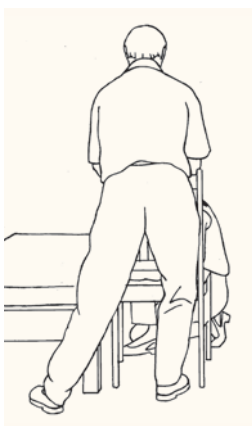

Action of carer at the back:

- 8 The carer at the back stands with his/ her legs apart and slightly bent, and then straightens his/ her legs to lift the person. The carer may also bend the knee closest to the bed to kneel on the bed.
- 9 The carer at the back now shifts his/her weight onto the leg closest to the bed and moves the person over.

Follow the steps above in reverse order to move the person back to the chair.



HOW SHOULD TWO PEOPLE MOVE A VERY WEAK PERSON FROM A CHAIR TO A HIGH BED?



- 1 The carers position themselves as described above. The carer in front can either kneel or squat down, with one leg in front of the other
- 2 The person's legs rest on the carer's thigh



- 3 The carer does the lift as described above. If the carer is short, he/she can stand on a sturdy step
- 4 The carer in front lifts the person's bottom and legs by standing up



- 5 The carer at the back transfers his/her weight onto the leg closest to the bed and moves the person over
- 6 The carer in front steps forward with his/her back leg and moves the person's legs and bottom onto the bed

HOW CAN A SINGLE PERSON HELP SOMEONE MOVE BETWEEN A BED AND A CHAIR?

The general principles are:

- Assist the person to shift his/her bottom forward on the seat or bed
- Place his/her feet slightly apart and behind the knees
- Ask the person to keep his/her back straight, bend at the hips and lean his/her head and shoulders forward over the knees
- Be careful to not be too close to the person. Move your own body back as they lean forward
- Ask the person to stand up straight as soon as his/her bottom lifts

HOW TO MOVE A PERSON THROUGH STANDING WHEN HE/SHE NEEDS SUPPORT AROUND THE WEAK KNEE?



- 1** Place the chair next to the bed
- 2** Support the weak knee on both sides with your own knees. Do not block the knee in front
- 3** Bring the person forward and up by moving the shoulders forward and upward
- 4** Twist towards the bed and sit the person down gently

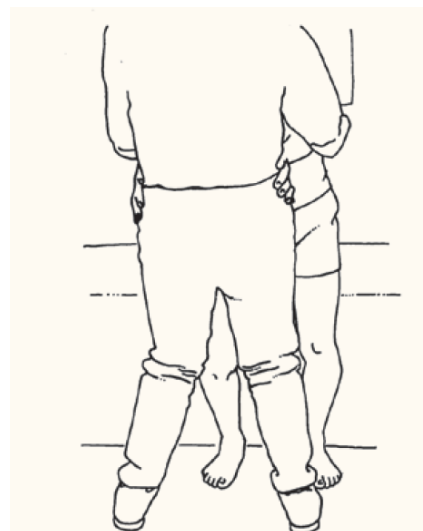

HOW TO MOVE A WEAKER, HEAVIER OR TALLER PERSON WITH A SLIDING BOARD?

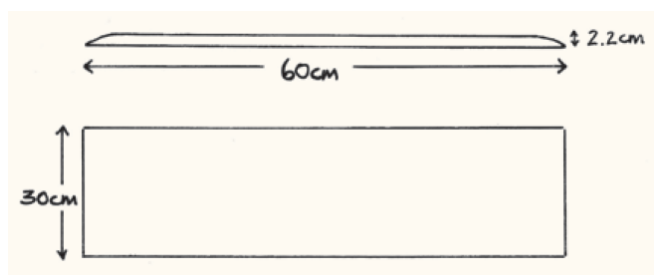
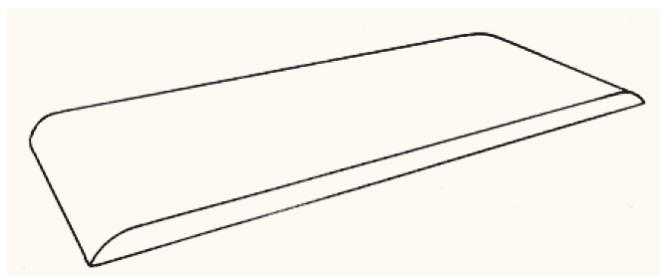

- 1** Position the wheelchair against the bed at a slight angle. Lock the brakes. Remove the armrest closest to the bed
- 2** Position yourself as you would when moving the person through standing
- 3** Lean the person away from the bed and insert the board under his/her buttock closest to the bed
- 4** Position the board to form a bridge between the bed and wheelchair
- 5** Ask the person to keep his/her back straight and lean his/her head and shoulders forward over the knees
- 6** Shift the person's bottom over when his/her weight is lifted off the board
- 7** If the person is weak, move only a short distance. repeat until he/she sits on the bed
- 8** Reverse these steps to get the person back into the wheelchair

?

HOW TO HELP SOMEONE WHO HAS STRONG ARMS AND WEAK LEGS?



- 1 Insert the board as described above.
- 2 Move behind the person and kneel on the bed with your leg closest to the bed. Position the other leg between the bed and the wheelchair.
- 3 Place your hands around the person's hips.



- 4 Ask the person to push down on his/her hands and lift up and shift the bottom sideways.
- 5 Help to lift and shift the bottom.
- 6 Repeat until the person is on the bed or chair.

?

HOW CAN I GUIDE SOMEONE WHO HAS WEAK LEGS AND STRONG ARMS TO MOVE FROM A CHAIR TO A BED WITHOUT HELP?

How to transfer with a board



- 1 Insert the board under the bottom.
- 2 Lean forward and take some weight through the feet.



- 3 Push down with the arms.
- 4 Move over by making short shifts to the side.
- 5 Don't stand up all the way.

?

HOW SHOULD TWO PEOPLE MOVE A VERY WEAK PERSON FROM A CHAIR TO A HIGH BED?



1 Help the person to shift on his/her bottom to the edge of the bed.

2 The person's feet should be slightly apart, in line with each other and slightly behind the knees.



3 Support the weak arm on your hip. If the arm is stiff or painful, leave it hanging between the person's knees.



4 Grip the person around the shoulder blade on the body, not on the upper arm. Support the person's arm with your forearm.



5 Guide the person's shoulders forward by shifting your weight onto your back leg.



6 Help the person stand. Allow him/her to do as much as possible by him/herself.

?

HOW CAN I GUIDE SOMEONE TO STAND UP WITHOUT HELP?

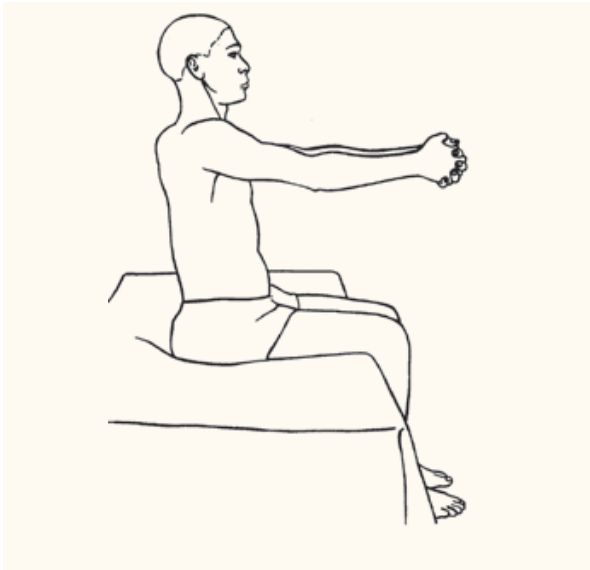

1 Sit up straight..

2 Clasp hands together or grip the weak arm just below the wrist with the thumb pointing to the fingers.



3 Shift forward on the bottom.

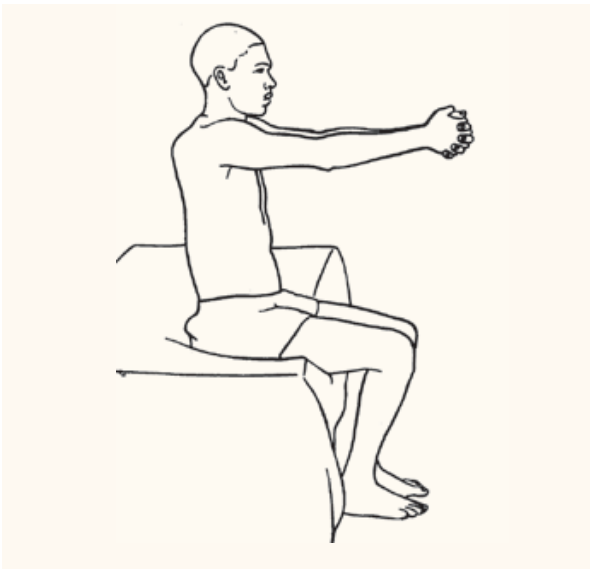

4 Stop at the edge of the bed. Place feet slightly apart, in line with each other and slightly behind the knees.

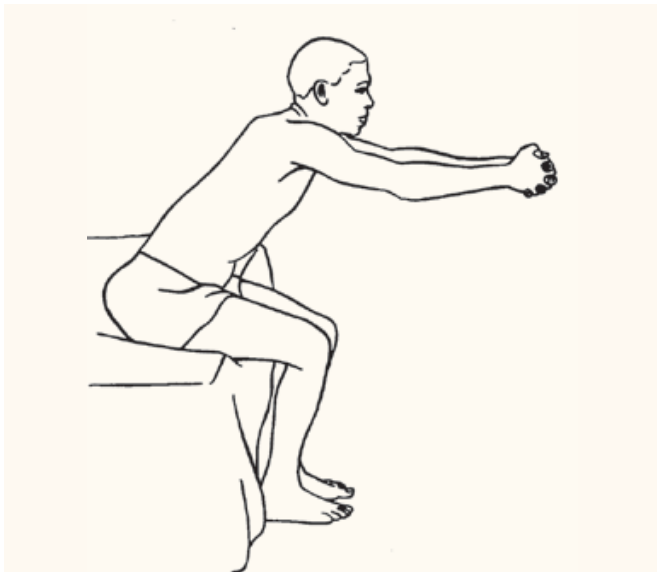

- 5** Lean forward from the hips until the shoulders are in front of the knees and feet. Reach forward with the hands to help bring weight forward.



- 6** Start lifting the bottom and straightening the knees. Do not push the knees back against the bed or chair.

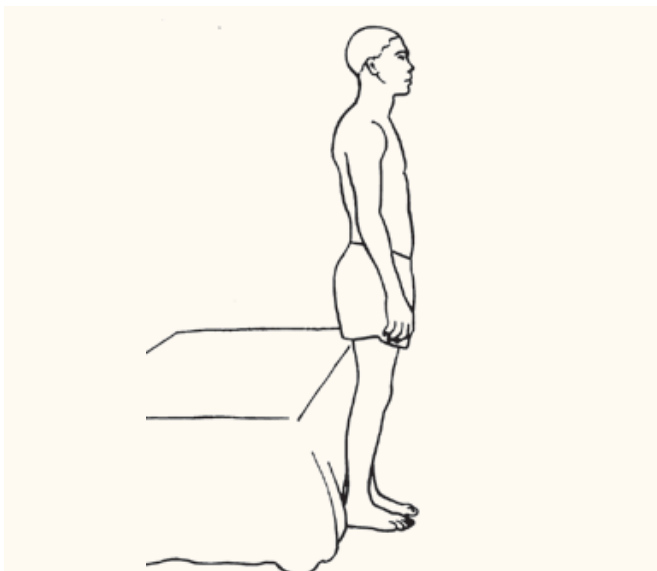

- 7** Stand up straight.



Never get up by pushing up using the strong hand only. If the person uses only the strong side of his/her body, it will cause more weakness and stiffness on the weak side. Rather stretch both hands forward and rest it against the back of a chair, a wall or other piece of furniture to help.



Control over bladder and bowel (toilet needs)

There are many reasons why people may struggle to control their bladder or bowel. Any person who experiences this should see a doctor, who can treat some of the problems and give medicine to improve control.

Let the person do as much as possible for him/herself.

HOW TO HELP A PERSON CONTROL HIS/HER BLADDER

Explain some general guidelines to the person, as follows:

- Drink six to eight glasses of water a day. Fill a two-litre bottle with water every day, and put it in the fridge or next to the bed or chair. Do not drink less just because you're afraid of having an accident.
- Don't drink anything at least an hour before bedtime if you experience night-time wetting.
- Go to the toilet just before bedtime and first thing in the morning.
- Cover the mattress with a plastic sheet, and cover the plastic with a towel or newspaper before covering it with a sheet. Do not lie or sit directly on the plastic cover.
- Go to the toilet every two hours. Slowly increase this time to every four hours.
- The colour of the urine should be only slightly darker than water. If it is darker, smells or contains blood, go to the clinic to be examined for possible infection. Urine with a dark colour usually means that you are not drinking enough water."

If the person wears a catheter (pipe and bag):

- Always wash your hands before and after working with the catheter.
- Empty the bag regularly.
- Do not strap the leg bag on too tightly.
- If there is no urine in the bag after four hours, the pipe may be blocked. Take the person to the clinic.

HOW TO HELP A PERSON WHO HAS NO BOWEL CONTROL

- A doctor should put the person on a bowel programme if the person experiences no sensation to indicate that he/she needs to go to the toilet.
- Set a bowel routine, such as going to the toilet every morning after breakfast.
- Let the person sit up on the toilet or commode.
- To prevent constipation:
 - The person should drink six to eight glasses of water a day.
 - The person should spend as much time as possible out of bed during the day.
 - The person needs to be as active as possible.
 - He/she must eat food containing roughage (fibre), for example unpeeled fruit, vegetables, dried fruit, bran, brown bread and brown rice.
- Take the person to the clinic if he/she has diarrhoea that lasts more than three days.



HOW SHOULD A BEDPAN BE USED?



1 Support the weak knee with your hand while the person lifts his/her hips.

2 Pull the knee forward and downward over the foot so that the foot doesn't slip or shoot out.



3 Insert the bedpan.

Use the bedpan only for urinating. Let the person sit up for bowel movements.



HOW CAN A SINGLE CARER HELP A PERSON TRANSFER TO A TOILET?



1 If it is not possible to place the wheelchair at 90 degrees to the toilet, place it at as much of an angle as possible. Put on the brakes.



2 Help the person to shift forward on the chair and to stand up.



3 Support the weak knee with your knees. Slide your hands onto the person's hips to help with balance.



4 Turn around until the person is standing in front of the toilet. Help remove his/her clothing.



5 Slowly guide the person to sit down.

?

HOW DOES A PERSON TRANSFER TO A TOILET WITHOUT HELP?



1 Put on the brakes of the wheelchair and shift forward onto the chair.

2 Clasp hands together.

3 Stand up.



4 Turn around.

5 Put clasped hands on the chair for support, if needed.



6 Sit down on the toilet.

7 If standing up without hand support is impossible, use a support rail and let the weak hand hang between the legs.

?

DEVICES THAT CAN HELP WITH GOING TO THE TOILET



Higher toilet seat: Works well for tall people, older people with hip and knee problems, or when the toilet is very low.



Plastic chair with hole in seat and a bucket underneath.

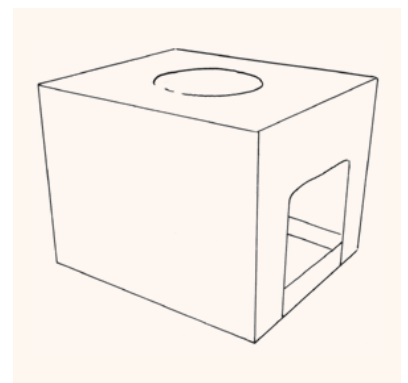

Make a commode from wood.

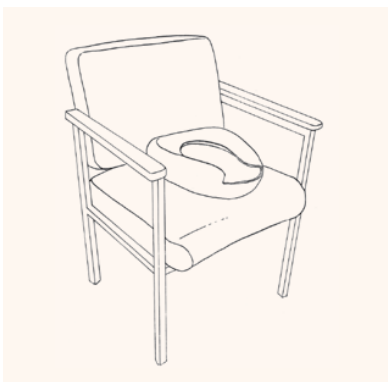

Use a bedpan on a chair with a hard seat.



Use a bedpan on a wheelchair.

WASHING

?

HOW SHOULD I WASH SOMEONE IN BED?



1 Stand on the weak side.



2 Move the person away from the side of the bed by lifting his/her head and shoulders, and moving the person to the middle of the bed.



3 Ask the person to move his/her hips by lifting the bottom and moving to the middle of the bed.



4 Loosen the shoulder before you lift the arm. Hook your hand around the shoulder blade and pull the shoulder blade gently outward and forward. Repeat this a few times until the shoulder moves freely.



5 Grip the arm just above the elbow and carefully turn it outward. Stop if the person feels pain. Do not grip the hand or lower arm because this may cause pain or damage to the elbow.



6 Straighten the elbow.



7 Keep the arm turned outward. Now move the arm up or forward. Stop if the person feels pain.



8 Wash and dry the arm and armpit.

To wash the back



- 1 Loosen the weak arm as described above. Keep the shoulder blade in a forward position.
- 2 Place the arm to the side before rolling the person over.

- 3 Roll the person onto his/her side.
- 4 Wash the back.
- 5 Use a towel under the body.
- 6 When the person is in this position, the sheets can also be changed.

To wash the bottom

- 1 Support the weak knee while the person lifts his/her bottom.
- 2 Wash underneath.



?

HOW CAN I WASH WITHOUT HELP?

- Sit on the edge of the bed.
- Feet should rest on the floor or on a wooden block or a stack of newspapers or cardboard tied together.
- Place a small table with a basin, cloth, soap and towel in front.
- While washing the upper body, support the weak hand and elbow on the table so as not to fall over and to prevent injury to the arm and hand. This will also help reaching into the armpit and washing the arm.



Wet the cloth.



Wash underneath the weak arm.



Wash underneath the strong arm.

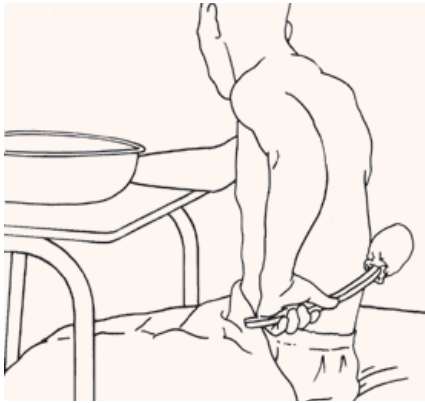

Wash the back with a back brush.

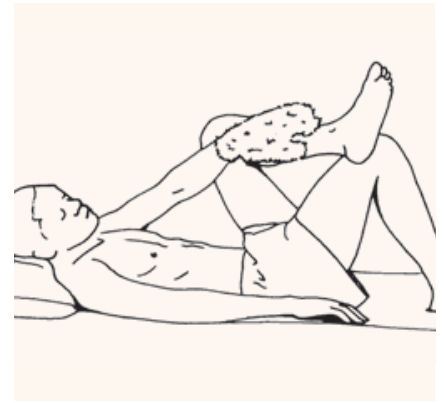

If balance is off, lie down on the back and cross one ankle over the other knee to wash the lower limbs.



Wash lower limbs while sitting if balance is off.

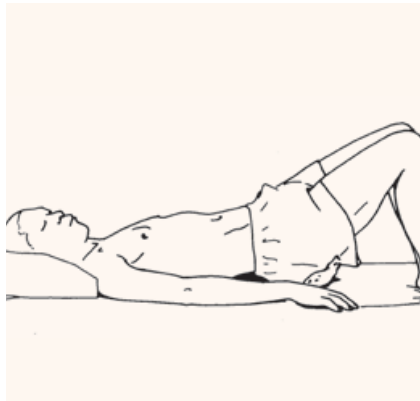

Lie down to wash bottom.

Use a non-slip rubber mat inside the bath to prevent slipping.

?

HOW DO I TRANSFER THE PERSON TO A BATH?



1 Transfer from a chair to the side of the bath or bath board.



2 Let the person sit on the bath board.

3 Lift his/her legs into the bath.

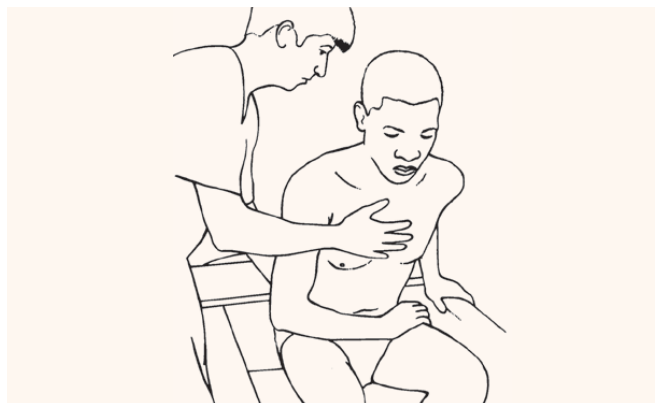

4 Move the person down onto the bath seat. He/she must hold firmly onto the side of the bath or rail with the strong hand. The weak arm can rest on the thighs.

5 Support the weak hand on the edge of the bath or bath rail if it has some power.

6 If the person is too weak to get down into the bath, he/she can be helped to wash or wash themselves while sitting on the bath board. A hand shower or height adjustable wall-mounted shower can be used.

7 If the person can get down a little lower, use a bath seat. A bath seat fits halfway between the top and bottom of the bath. See two examples of bath seats below.



DEVICES THAT CAN HELP IF A PERSON CANNOT SIT DOWN IN A BATH

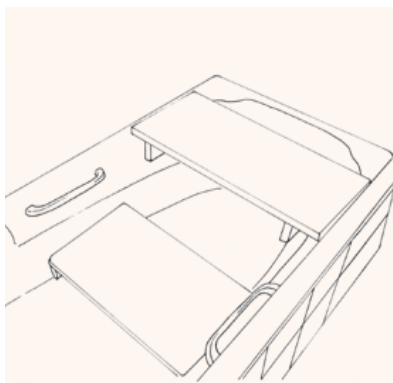

Bath board on top of bath, with bath seat inside bath



Bath board



Bath seat



Slatted bath seat



Turning bath chair



Measurements and technical details for a bath board.

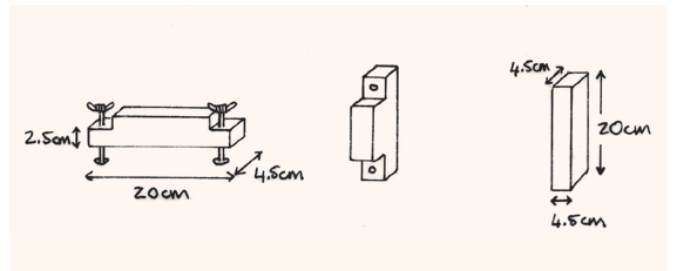
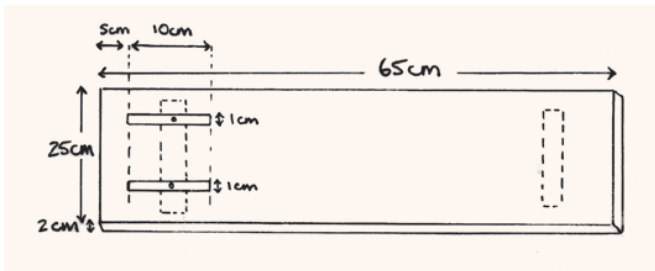

Measurements and technical details for a bath seat.

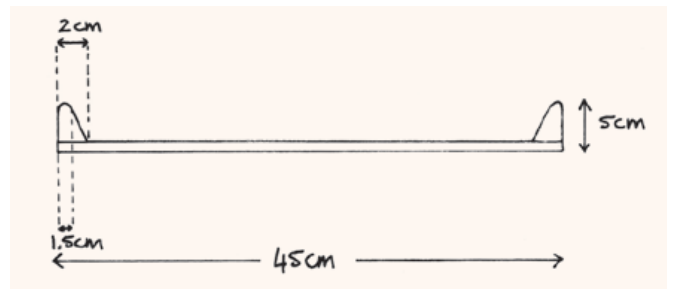
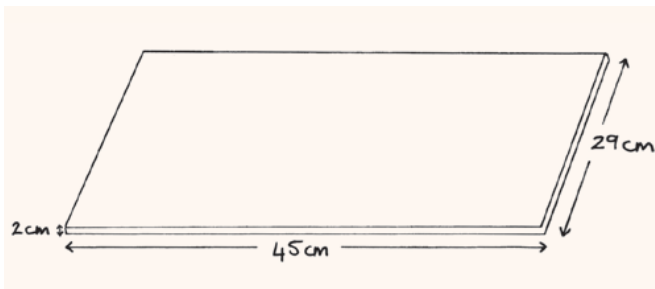

Measurements and technical details for a slatted bath seat.

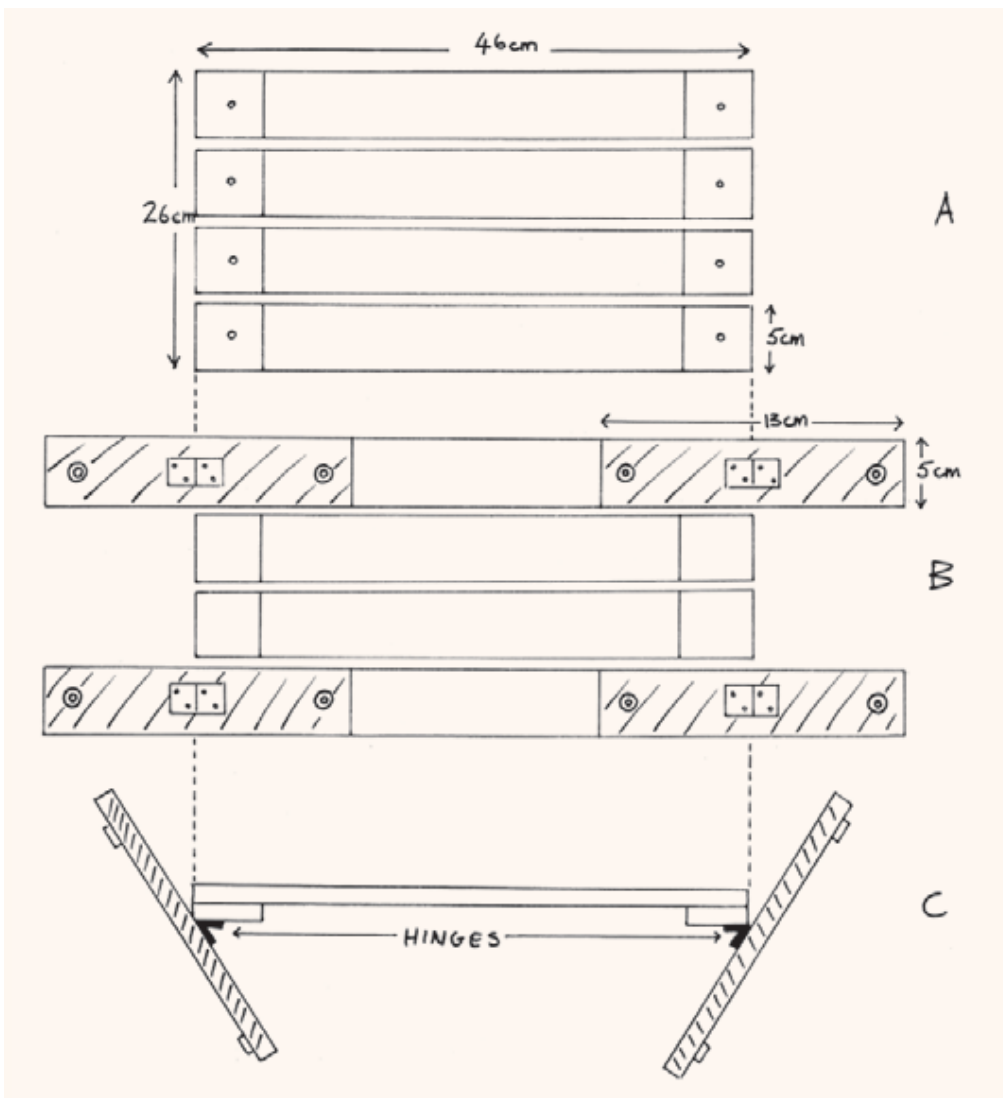

A. Diagram of seat.

B. Diagram of sides.

C. How to join seat and sides.



HOW CAN I GUIDE SOMEONE TO TRANSFER TO A BATH WITHOUT HELP?

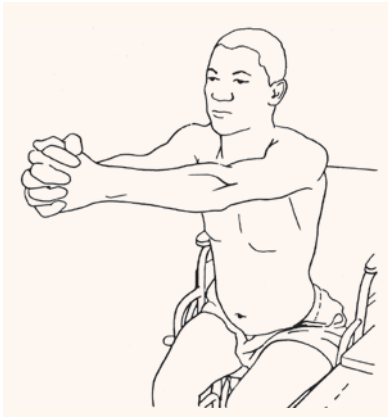

- 1** Clasp hands together and stand up.

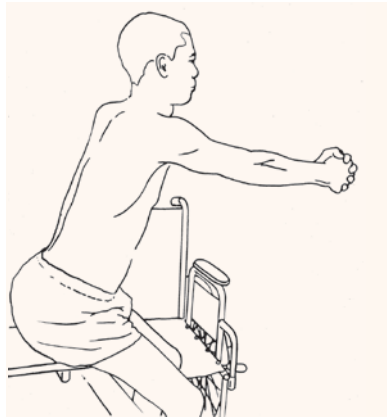

- 2** Turn and sit down on the bath board.



- 3** Support the weak leg around the knee and lift it into the bath.



- 4** Push with the hands down onto the edge of the bath.



- 5** If the weak hand is too weak, place it on the opposite thigh and lower the body down onto a bath stool or into the bath.



- 6** Wash the body.



- Make a hole in the soap. Tie soap onto a rope.
- Hang soap around the neck so that it does not fall and slip away.



- Drape a cloth over the knee and soap it.

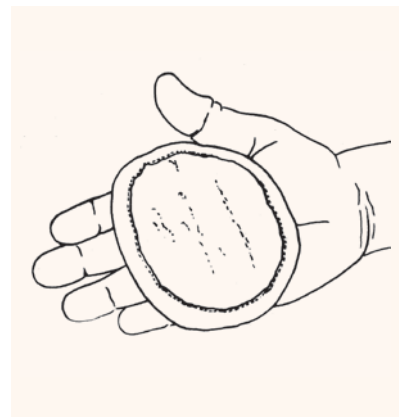

- Use a sponge with elastic that goes around the back of the hand.

Make a back brush:

- 1 Use a coat hanger.
- 2 Wrap a sponge around the one end.
- 3 Cover the sponge with towelling material.



WHAT GUIDELINES SHOULD I FOLLOW TO HELP SOMEONE DRESS?

Let the person do as much as possible for him/herself:

- 1 The person sits on the edge of the bed with his/her feet resting on the floor. If the person cannot balance on the bed, let him/her sit on a chair with a firm seat and backrest.
- 2 Start with undressing, because it is easier.
- 3 Use wide, loose-fitting clothes.
- 4 Do not use clothes that are difficult to fasten.
- 5 Dressing is a slow process. Allow enough time.
- 6 Encourage the person with positive comments.
- 7 If the person cannot perform the whole task, break it down into smaller steps, for example only putting the arms into the sleeves. Only help when it is necessary.
- 8 Always dress the weak side first and undress the strong side first.

How to put on a shirt or a jacket



- 1 Let the person put the shirt on his/her lap. The inside faces upward, with the collar towards the knees. The weak arm's sleeve hangs between the legs.



- 2 Let the person bring the weak arm towards the lap.



- 3 Put the weak hand into the sleeve opening.



- 4 Pull the sleeve up over the weak hand and arm until the hand can be seen. Throw the rest of the shirt towards the back.



- 5 The person now pulls the sleeve up over the elbow.



- 6 He/she pulls the sleeve up and over the shoulder

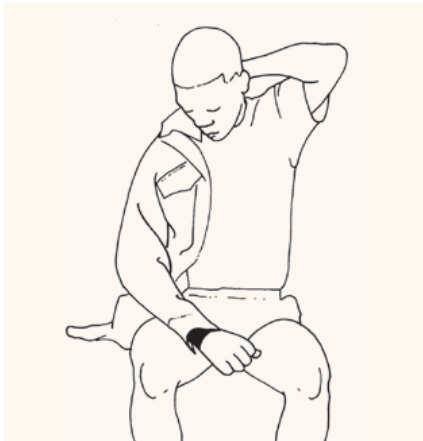

7 The shirt is brought around the back.



8 Let the person put his/her strong arm into the sleeve.



9 Fasten the buttons.

How to put on pants



1 Let the person place the pants on his/her strong side.



2 He/she crosses the weak leg over the strong one.



3 The weak foot goes into the pants leg.



4 The person pulls the pants up over the knee and uncrosses the legs.



5 Now the strong foot goes into the pants leg.



6 The person pulls the pants up over the knees.

If the person is very weak



- 1 The person pulls the pants up over the legs by hooking the strong foot underneath the weak leg, supported on the elbow, and then lies down on the bed.

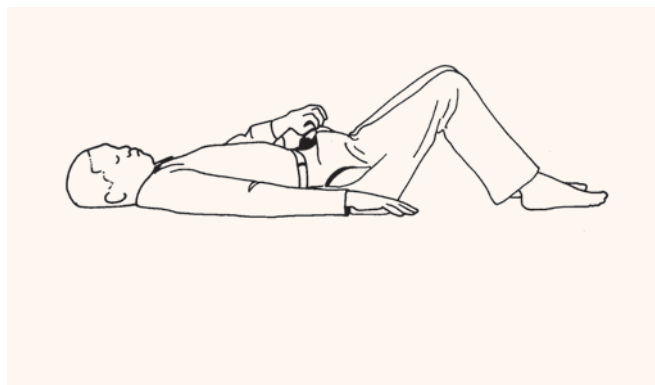

- 2 The knees are bent.
- 3 The person lifts his/her bottom.
- 4 He/she pulls up the pants over the bottom.
- 5 The bottom goes down onto the bed again.
- 6 The zip and belt may now be fastened.
- 7 The person sits up again.

If the person can stand with help



- 1 The person stands up with help (with the carer on the weak side).
- 2 The person can rest his/her arms on the back of a chair or other piece of furniture for balance.
- 3 Carer pulls pants up.

If the person can stand on his/her own

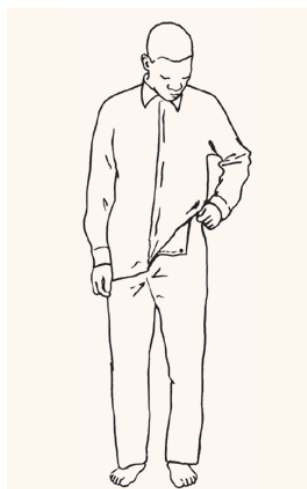

- 1 The person stands up with help (with the carer on the weak side).
- 2 The person can rest his/her arms on the back of a chair or other piece of furniture for balance.
- 3 Carer pulls pants up.

How to put on a jersey or sweater



1 The person puts the jersey on his/her lap, with the back facing towards him/ her and the bottom end towards the body. The neck of the jersey is at the knees.



2 Let the person open the jersey from the bottom.

3 He/she finds the sleeve opening for the weak arm.



4 He/she puts the sleeve between the knees.

5 The sleeve opening is held open with the strong hand.



6 The weak hand goes into the sleeve opening.



7 The person now pulls the sleeve up over the elbow.



8 Now it is pulled up over the upper arm.



9 The jersey is pulled up over the shoulder.



10 Now the strong arm goes through.



11 Then the head follows.



12 The person can also put his/her head through first.



13 The strong arm then follows.



14 Finally, he/she pulls down at the back to neaten up.

How to put on socks



1 Use socks with a lot of stretch. The sock should be folded halfway back to the heel cap.



2 Let the person cross the weak leg over the strong leg.

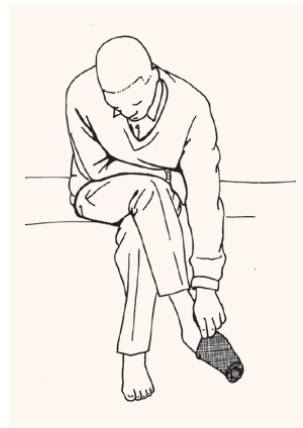

3 He/she then pulls the sock over the toes.

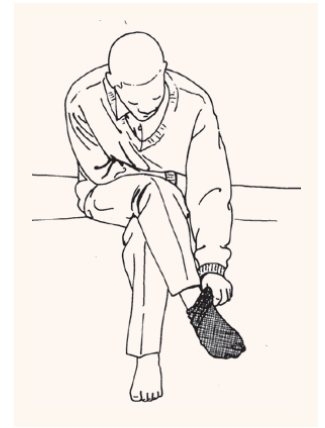

4 The sock is then pulled up over the foot and ankle.

How to put on shoes

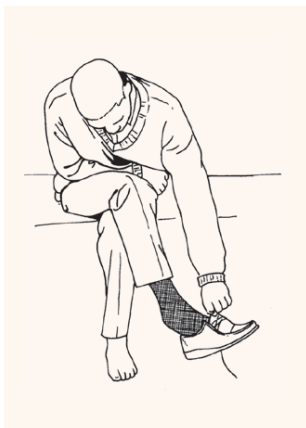

1 Let the person cross the weak leg over the strong leg.

2 He/she pulls the shoe over the toes. Use slip-on shoes or shoes with Velcro fasteners.



3 3. The foot is pushed in.



4 The foot is now put on the floor and the person presses on the knee to push the heel in.

WALKING WITH HELP



WHAT IS THE CORRECT WAY TO HELP SOMEONE TO WALK?

General principles:

- 1 Support the person from the weak side.
- 2 Put your hip against the back of the person's weak hip.
- 3 Your foot can help along the person's weak foot, if necessary.
- 4 Put one hand firmly around the person's body.
- 5 Your other hand holds the person's weak hand. If the person is very weak, put your free hand on his/her tummy so that you can hold him/her tightly between your two arms.
- 6 Give the person space to move his/her body.
- 7 If you stand too close or hold on too tightly, both of you will struggle to stay upright and walking will be more difficult.

If the person is very weak, use a walking stick on the strong side. Both the carer and the person must wear comfortable, sturdy, non-slip shoes or walk barefoot. Do not walk on socks!

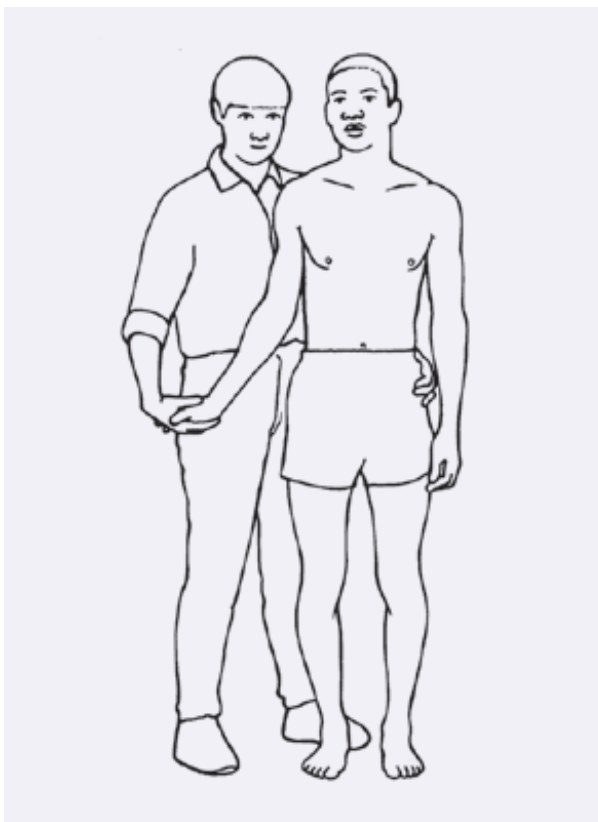

From the front.

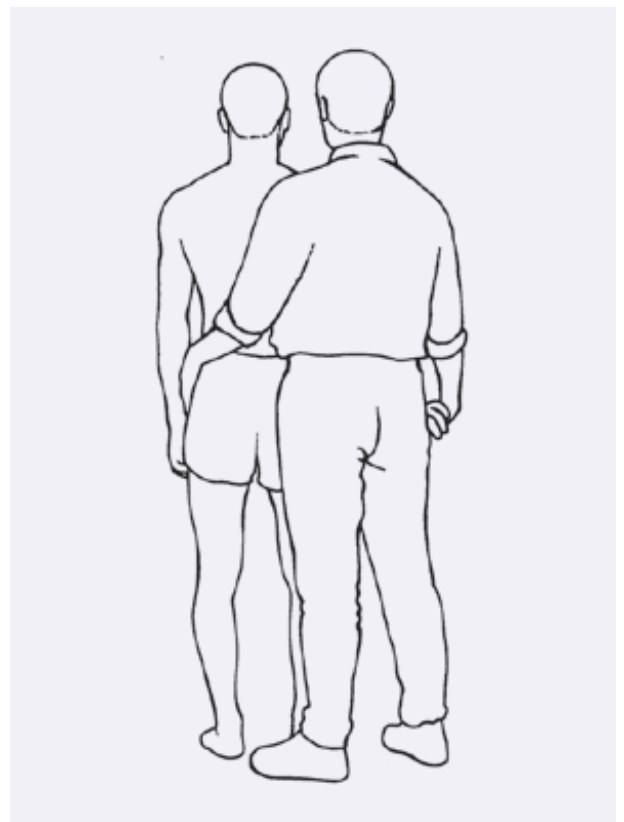

From the back.

The correct grip

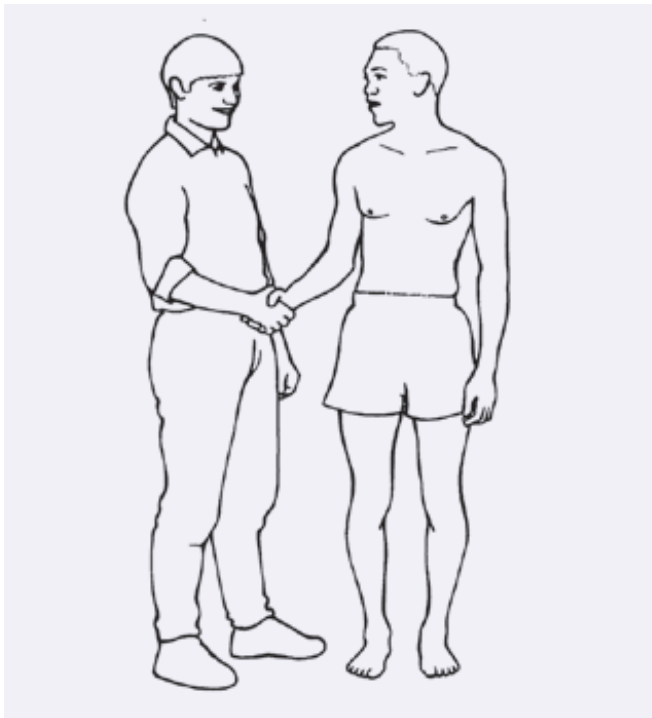

- 1** Start as if shaking hands, but turn your palm up while holding the person's hand.
- 2** Grip the weak hand.
- 3** Do not pull on the weak arm.

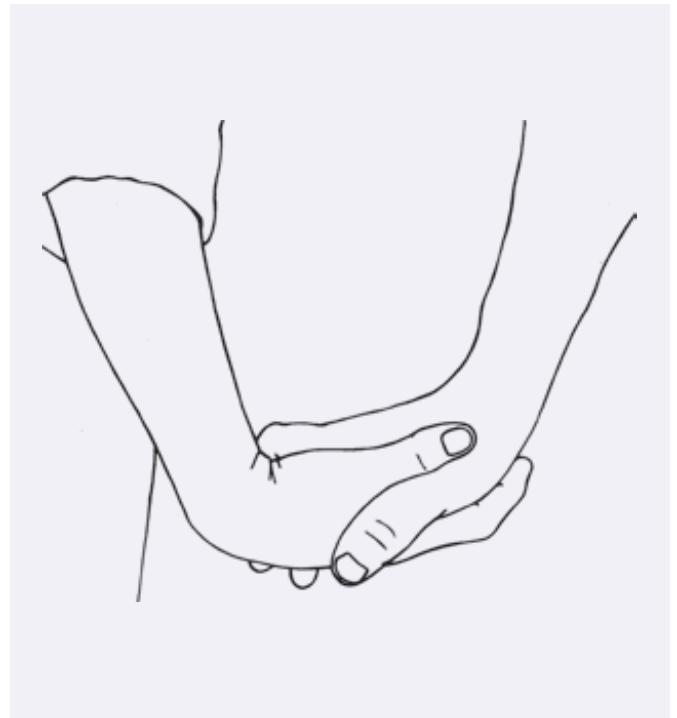

- 4** Support the arm by pressing upward through the hand.
- 5** Keep the person's elbow straight against your body. In this way, the arm remains straight and the person can lean on your hand for support. This also helps him/her to stay upright.

Alternative grip:



This is a good grip to use if the person has a stiff wrist.

- 1** Hook your thumbs together.
- 2** Grip the person's hand along the base (bottom) of the thumb.
- 3** Make sure that the person does not feel any pain in his/her wrist.

COMMON PROBLEMS AFTER A STROKE

PROBLEM

SEEK HELP FROM

Shoulder pain/shoulder and hand pain

Physiotherapist/occupational therapist

Urinary tract (bladder) infections

Clinic/doctor/ nurse

Constipation/diarrhoea

Clinic/doctor/ nurse

Sliding or falling out of wheelchair

Seating clinic/professional with training in wheelchairs and seating/physiotherapist/ occupational therapist

Behaviour problems

Occupational therapist/clinical psychologist/ social worker

Aspiration (choking or coughing after swallowing)

Speech therapist/nurse

Bedsore

Clinic/doctor/ nurse as well as the physiotherapist/occupational therapist

Shortening of muscles/tightness of muscles/muscle spasms

Physiotherapist

Depression

Clinic/doctor/occupational therapist/social worker

Double vision or only seeing on one side

Clinic/optometrist/occupational therapist

Make sure that stroke survivors take their prescribed medicine.

Name and contact details of service providers in your area

ACKNOWLEDGEMENTS

The authors would like to thank the following persons, without whose assistance this document would not have been possible:

The authors would like to thank the following persons, without whose assistance this document would not have been possible:

1. Jenny Hendry, who initiated the project, assisted with the motivation for funding, played a valuable role during the planning phase, and provided input during final editing.
2. Gubela Mji for taking over the project from Jenny Hendry and providing ongoing motivation.
3. Deona Roets for her input in the section on speech and swallowing.
4. The then Tygerberg Department of Dentistry for providing the models and information on tooth and mouth care.
5. Andrienne Human, the photographer, for her patience and perfectionism.
6. Models for line drawings: Neels Olivier, Jeanette Oliphant, Christa Prins, Deona Roets, Lynette Vorster, Elizabeth Brandt, Susan Human, Maria Britz and Mandy Smith.
7. Art Department: Tygerberg campus, Stellenbosch University, for the initial line drawings.
8. Kim McDonald for the balance of the line drawings and the precision and accuracy with which she continued from the previous artists.
9. Sheena Irwin-Carruthers, Helen Sammons and Jacqui Goeller for proofreading the final product.
10. The stroke survivors, their families and carers for their feedback during the development phase.
11. The participants of two of the 2010 three-week adult basic Bobath courses who took part in the formal peer review process.

Special acknowledgement is given to Boehringer Ingelheim for funding the 2015 edition's editing and translation into Afrikaans, Sesotho, Xhosa and Zulu.



WHY HAVE WE WRITTEN THIS BOOKLET?

Stroke is a complex condition, and caring for a stroke survivor is a challenge. What makes this situation worse is that there are very few community rehabilitation services available. Many people are not even admitted to a hospital after a stroke, and those who are admitted are often discharged within 48 hours.

Home carers and caregivers are inadequately trained and supported, and have to cope as best they can. Caregivers struggle to communicate with the person and do not always understand the behaviour problems caused by the stroke. They find it difficult to help the stroke survivor with physical activities such as dressing and transfers. This results in problems, which are actually easily preventable, such as painful shoulders and hands, contractures and poor habit patterns.

In 1995, funding was obtained from the then Portnet as part of its Restructuring and Development Plan to develop a training package, which included a four-hour training programme for home carers and other care institutions, such as old-age homes, as well as a training manual that reinforced the practical aspects addressed during training. This training package was developed through a joint effort by the Centre for Rehabilitation Studies of Stellenbosch University and the Western Cape Rehabilitation Centre.

Over a period of ten years, it has been refined and modified according to needs expressed and feedback received from both trainees and stroke survivors. The suitability of this document was evaluated as part of a master's study by Dr Janine Botha. Recommendations from this study have been implemented as well. The complete manual is now available.

The authors hope that this manual will provide an easy, accessible guide for carers for use as a reference at home. It is not meant to replace training, but to be used by carers to aid memory after they have completed their training. Carers need to spend adequate time in training to ensure that they have the appropriate and adequate skills.

Centre for Rehabilitation Studies, Stellenbosch University

The Centre for Rehabilitation Studies offers unique post-graduate programmes (MSc/MPhil) in rehabilitation to professionals from health and related fields. The approach is interdisciplinary, with the emphasis on the development of leadership skills to facilitate development, management and evaluation, as well as research into appropriate and cost-effective rehabilitation and disability programmes. The Centre for Rehabilitation Studies also plays a supportive role in curricular development within the Faculty of Medicine and Health Sciences in respect of disability and rehabilitation-related aspects.

The Centre is unique in offering comprehensive rehabilitation education and training programmes, research and service opportunities for all health sciences and rehabilitation-related professionals at all levels of health services and in the community.

<http://www.sun.ac.za/crs>

The Western Cape Rehabilitation Centre for Persons with Physical Disabilities

The Western Cape Rehabilitation Centre (WCRC) is committed to the efficient and effective rehabilitation of persons with physical disabilities. We offer comprehensive rehabilitation programmes on an in/outpatient basis to promote clients' full participation in society. Characteristics of our services include client-centeredness, an outcomes-based approach and an interdisciplinary teamwork.

WCRC has an in-patient capacity of 156 beds. Clients are admitted from public and private acute hospital settings as soon as they are medically stable and able to participate actively in our rehabilitation programmes. The outpatient services include assessment/screening, follow-up rehabilitation, specialised clinics and outreach initiatives.

The vision of the WCRC is to be the world leader in the rehabilitation of persons with physical disabilities.

<http://www.wcrc.co.za>





UNIVERSITEIT•STELLENBOSCH•UNIVERSITY
jou kennisvenoot • your knowledge partner

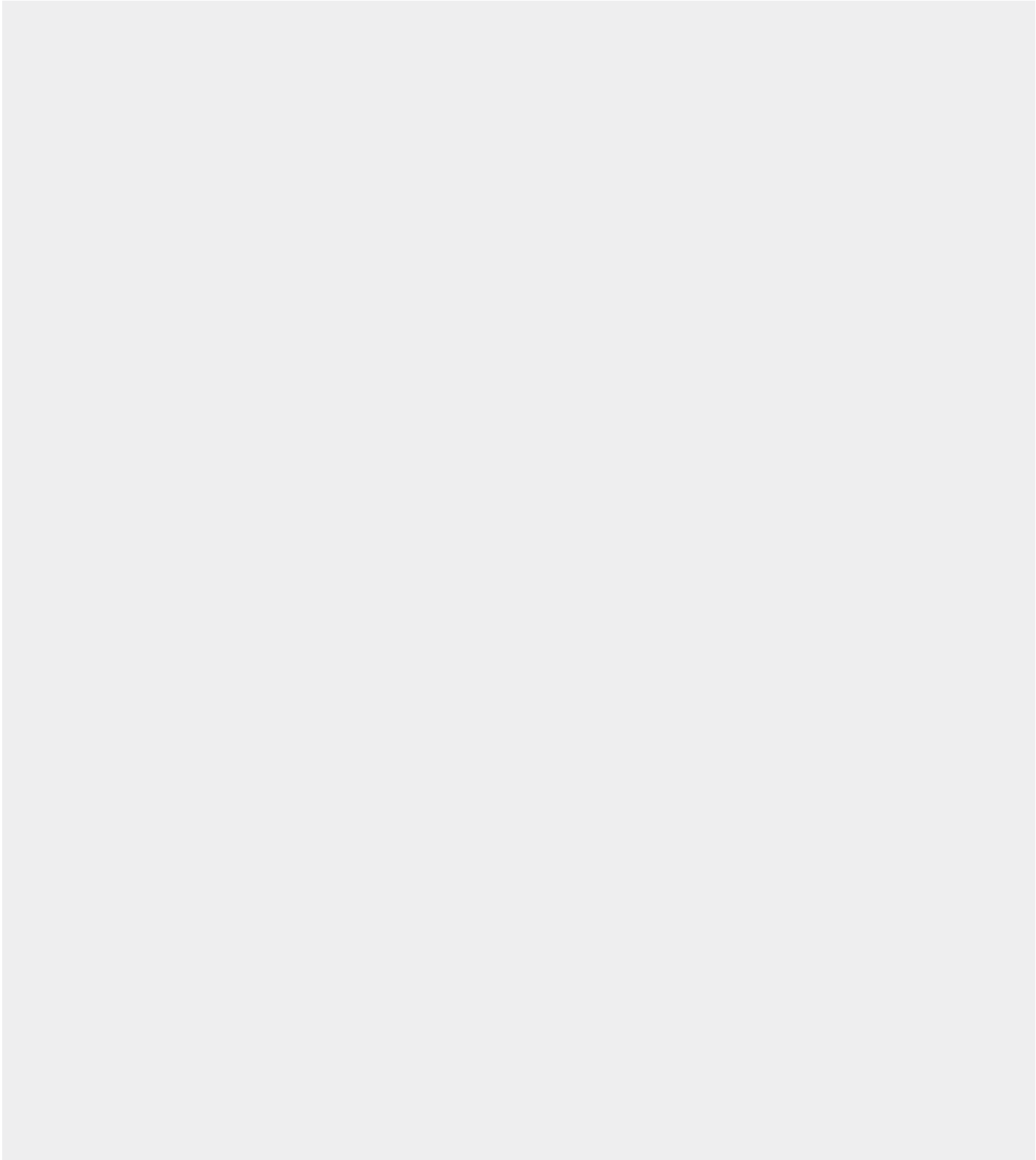

SUPPORTED BY

